

# P.01 - PLATFORM & FLOORING

---

## KIT STRUCTURE SYSTEMS SERIES DATA SHEETS

V>SELF 40 Series

V>EASY 50 Series

V>CORE 80 Series

V>LINE 100 Series

V>KING 120 Series

V>GIANT 150 Series

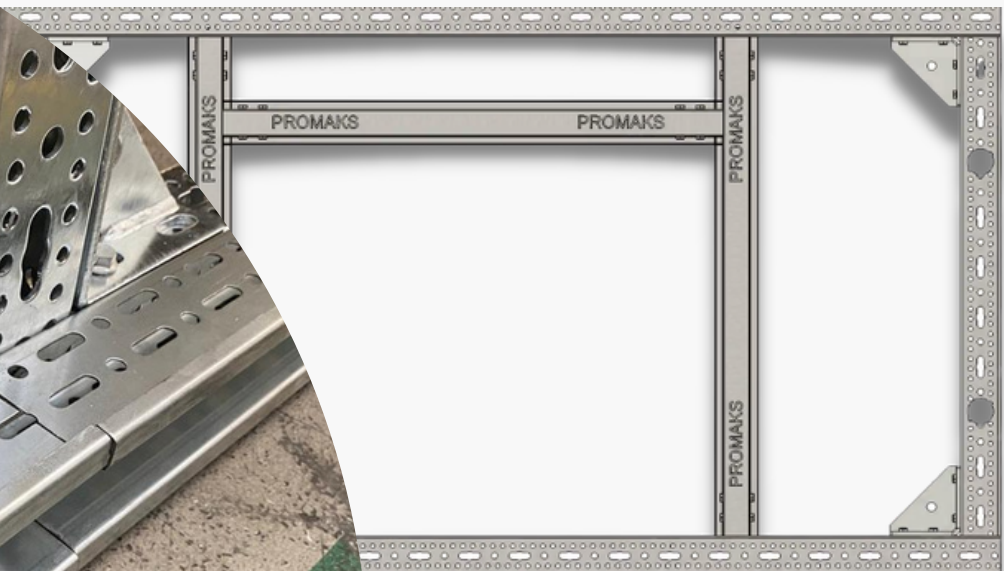
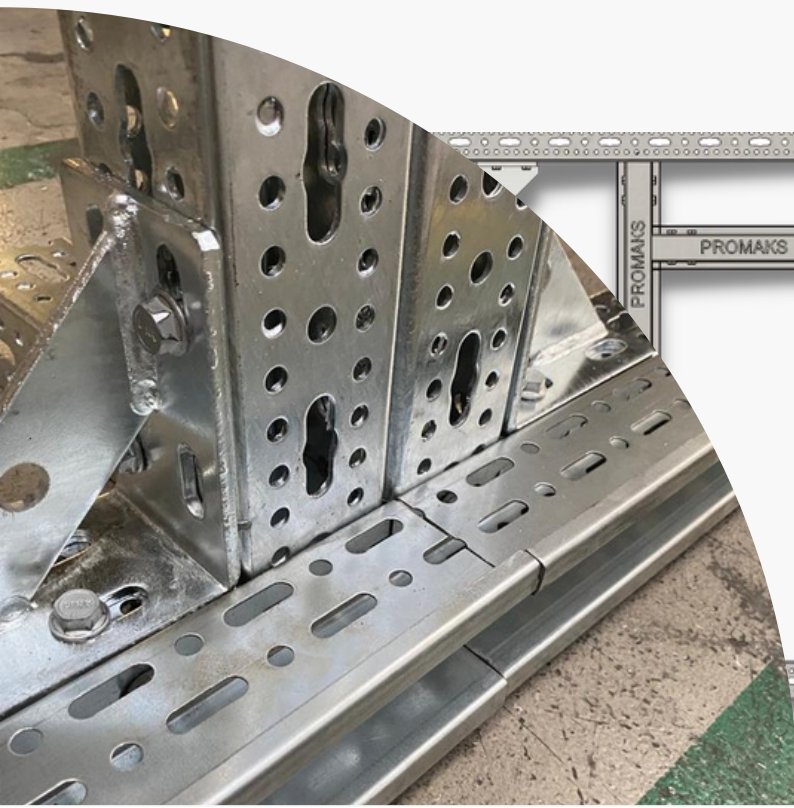

# About ProMAKS

ProMAKS V-Series is a structure technology designed for faster, flexible and durable building solutions with high capacity production.

We offer our range of innovative systems available as flat packed kits, complete with everything you need to build to an exterior finish, freeing you up to focus on the design & finish of the interior to your client's specifications.

- Ventilated Structure
- Energy Efficiency
- Smart Connection
- Quick and Easy Assembly
- Flexible Design
- Effective Insulation
- Easy to integrate - flexible
- Versatile Structure

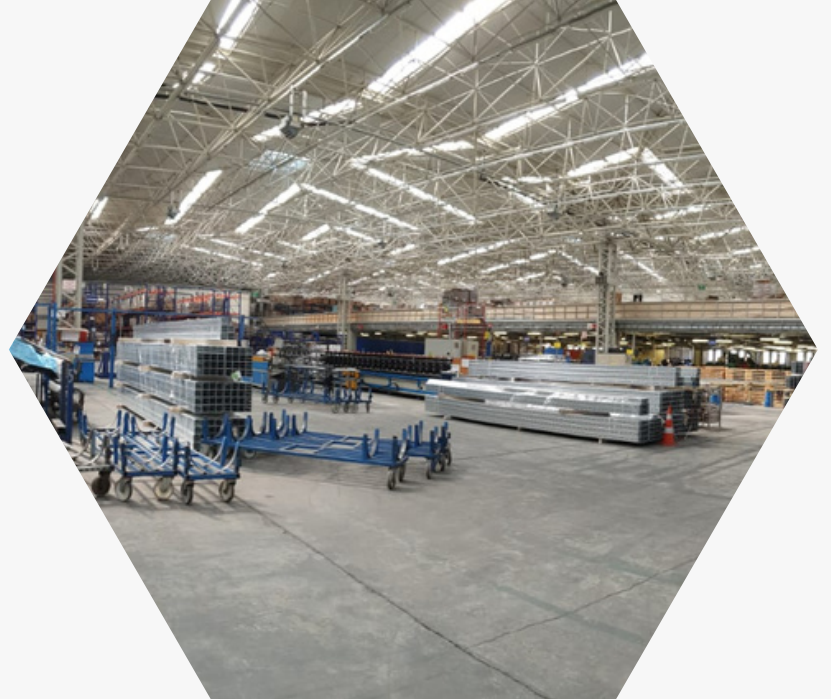

# VSELF 40 Series

*design as you like...*

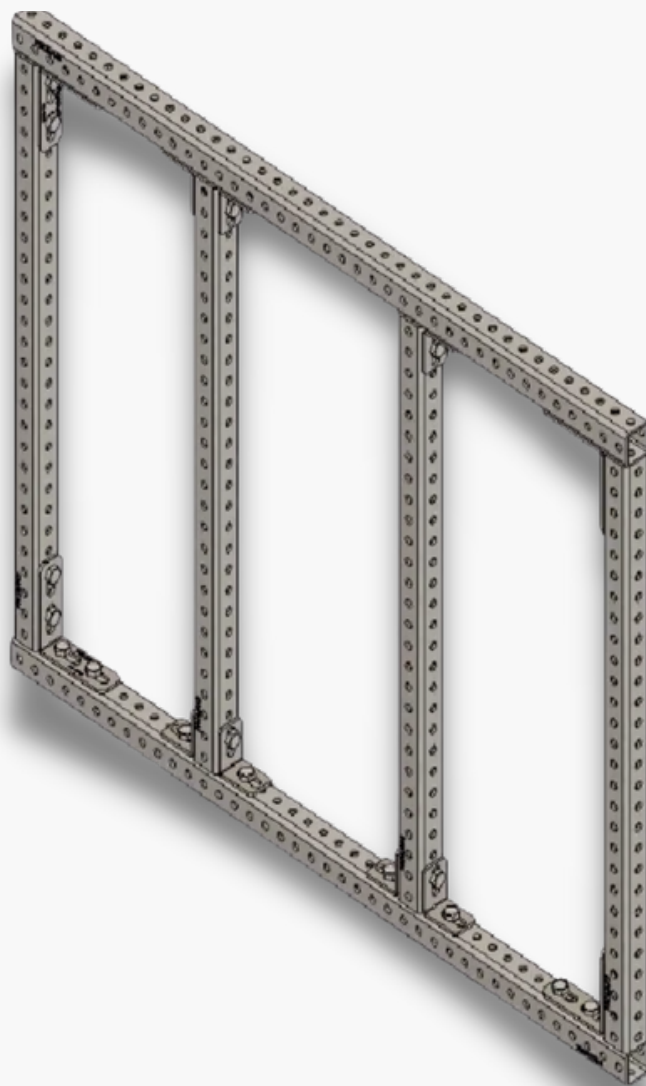
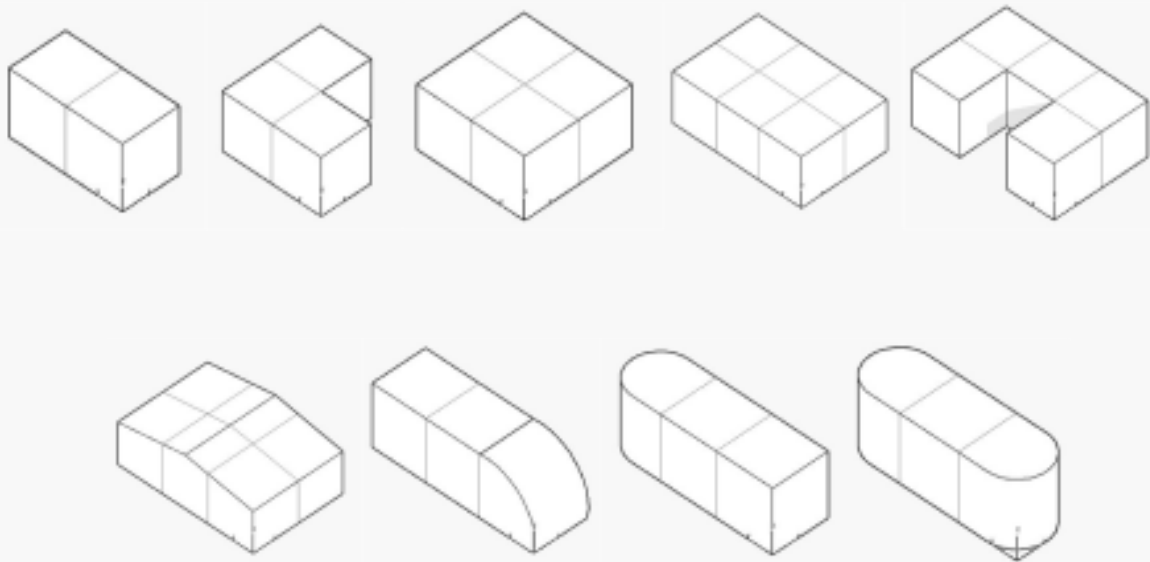

# V>SELF 40 Series

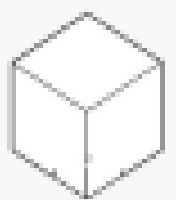
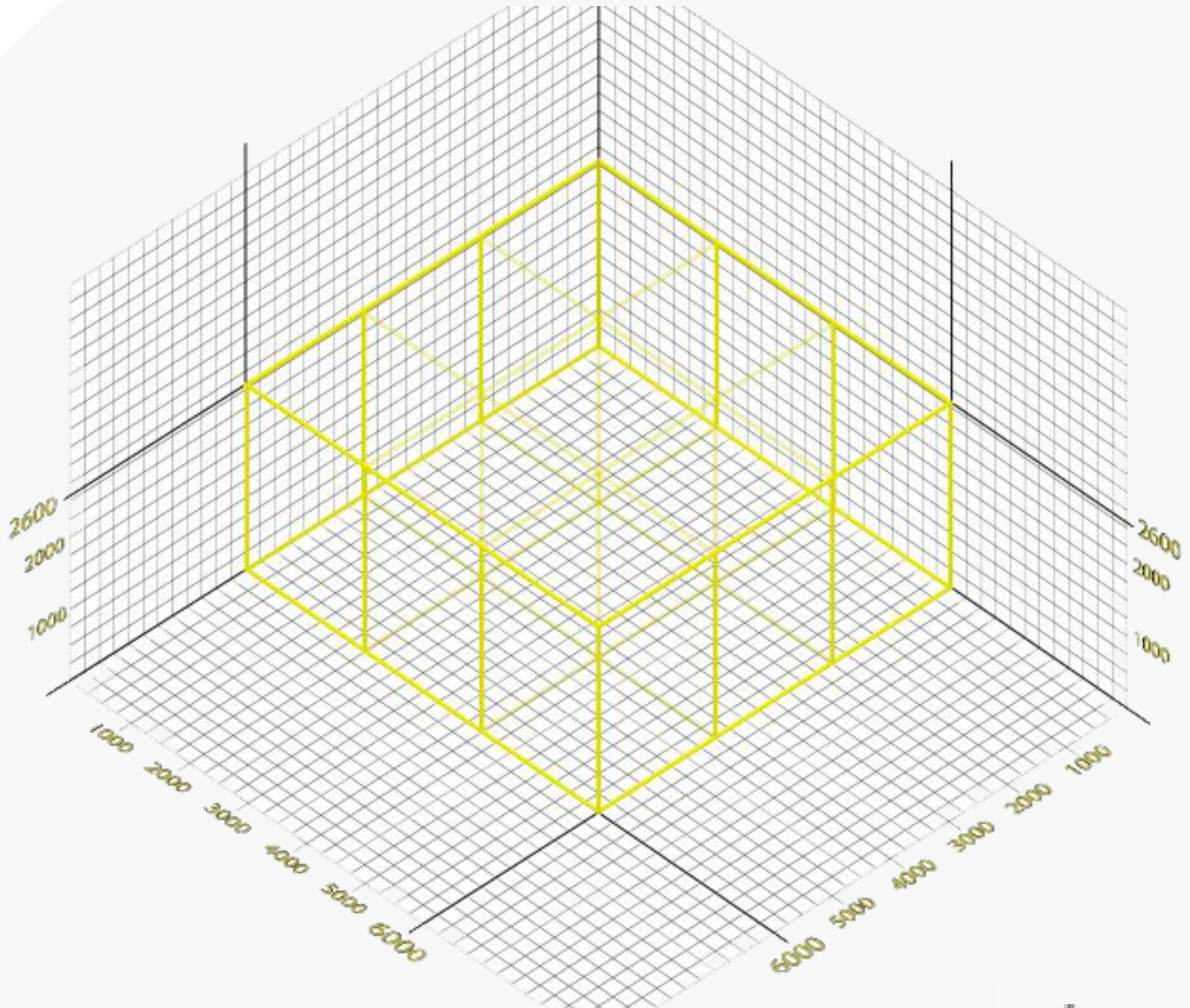

Base Module : 2.0 x 2.0 x 2.6 m

## Smart Connection



PMKS-KD-450  
Promega Connection

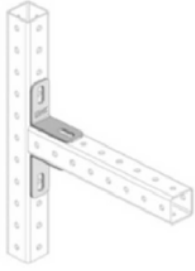

PMKS-KD-451  
Promega Connection

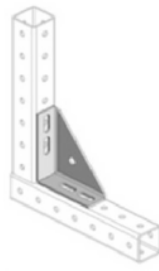

PMKS-KD-452  
Promega Connection



PMKS-MFS-040/050  
Promega Connection

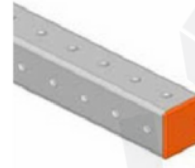

PMKS-PC-050  
Promega Connection



PMKS-TTA-040/050  
Promega Connection

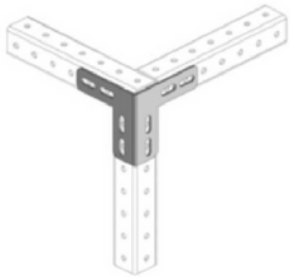

PMKS-TDE-040/050  
Promega Connection

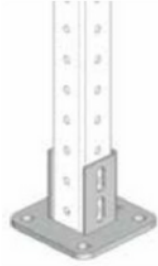

PMKS-TTA-041/051  
Promega Connection



PMKS-TTY-040/050  
Promega Connection



PMKS-TTY-041/051  
Promega Connection

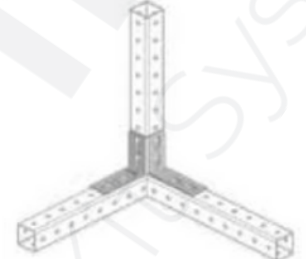

PMKS-TTY-042/052  
Promega Connection

## ProMAKS Profile

### PMKS-PRF-040-001

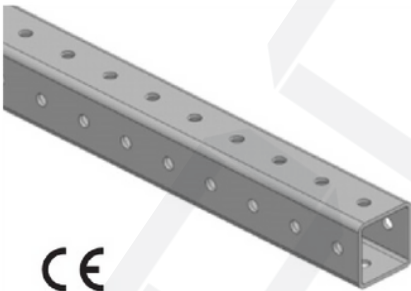

25mm  
Ø 9,5

Delik arası mesafe: 25 mm  
Delik çapı: 9,5 mm  
Distance between holes: 25 mm  
Hole diameter: 9,5 mm

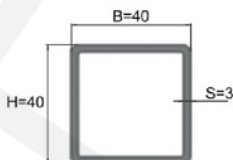

## Connection Pieces



PMKS-KD-450

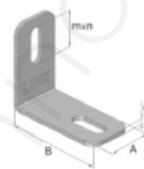

PMKS-KD-451

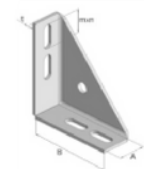

PMKS-KD-452



PMKS-MFS-040/050



PMKS-KOD-100-001



PMKS-PC-050

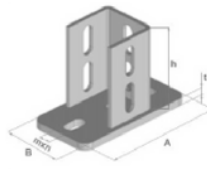

PMKS-TTA-040/050

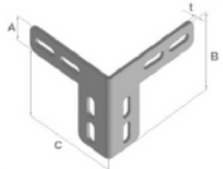

PMKS-TDE-040/050

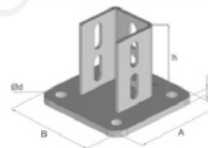

PMKS-TTA-041/051

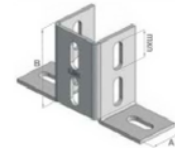

PMKS-TTY-040/050



PMKS-TTY-041/051

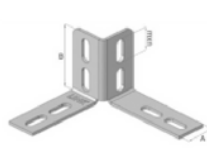

PMKS-TTY-042/052

# Medium Duty V-SELF Series Structural Systems

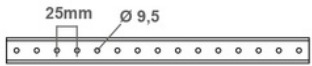
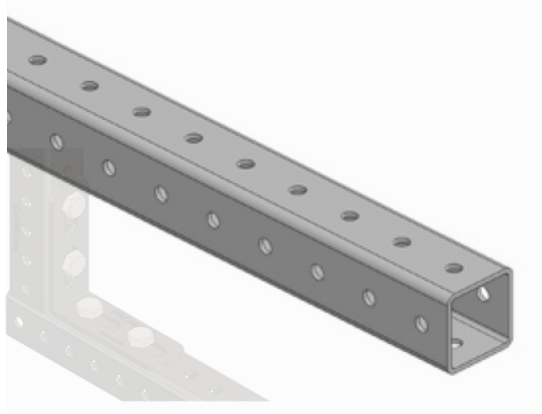

Distance between holes: 25 mm  
Hole diameter: 9,5 mm

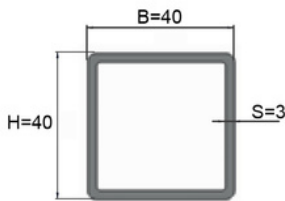

## Service

Promaks is modular kit structural system, provide easy installation with self-threading bolt and medium load capacity due to its special design.

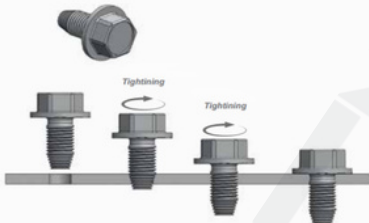

## Materials and Type

Steel S235 JR

## Coating

EN 1461 Hot-dip galvanized 92µm minimum Hot-dip of galvanize.

## Section Properties

Profile Size			Unit Weight (kg)	Cross Section Area (mm <sup>2</sup> )	Torsional Section Modules (cm <sup>3</sup> )	Torsion Moment of Inertia (cm <sup>4</sup> )	Moment of Inertia (cm <sup>4</sup> )		Section Modules (cm <sup>3</sup> )	
H	B	S					I <sub>y</sub>	I <sub>z</sub>	W <sub>y</sub>	W <sub>z</sub>
40	40	3	3,10	309,00	8,13	14,77	7,38	7,38	3,69	3,69

The section properties is determined according to the perforated section.

## Distributed load

Lmax (mm)	q <sub>z</sub> , perm kN/m	F <sub>z</sub> , (q <sub>z</sub> ,perm *L) kN
500	20,00	10,00
1000	4,15	4,15
1500	1,20	1,80
2000	0,50	1,00
2500	0,25	0,63

q<sub>z</sub>[kN/m] as permanent load at L

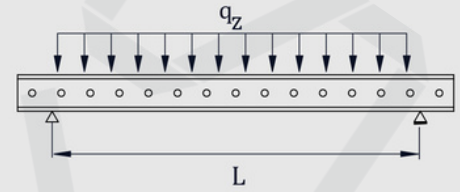

## Point load

Lmax (mm)	F <sub>z</sub> , perm kN
500	4,80
1000	2,40
1500	1,15
2000	0,63
2500	0,37

F<sub>z</sub>[kN] as permanent load at L/2

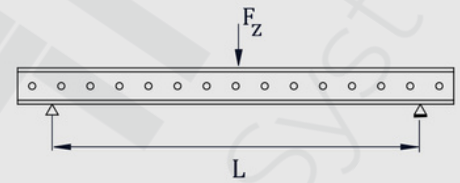

## 2 Point loads

Lmax (mm)	F <sub>z</sub> , perm kN
500	3,70
1000	1,50
1500	0,65
2000	0,36
2500	0,22

F<sub>z</sub>[kN] as permanent load at L/2 and 2\*L/3

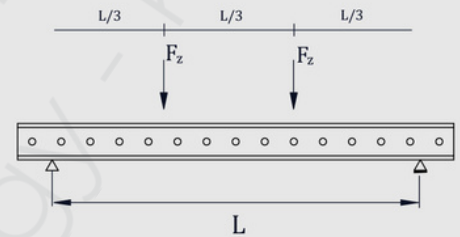

## 3 Point loads

Lmax (mm)	F <sub>z</sub> , perm kN
500	2,5
1000	1,10
1500	0,48
2000	0,26
2500	0,16

F<sub>z</sub>[kN] as permanent load at L/4, L/2 and 3\*L/4

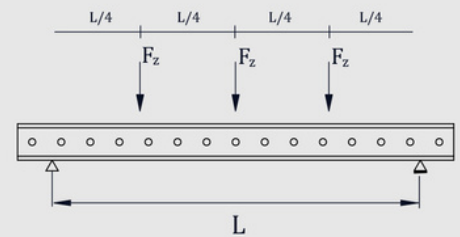

- Basis of calculation of the load capacity is accordance with Eurocode 3 (EN 1993)
- Self weight considered.
- Safety factor is taken into account as 1,35.
- Deflection limit value is L/200.

# V-EASY 50 Series

*design as you like...*

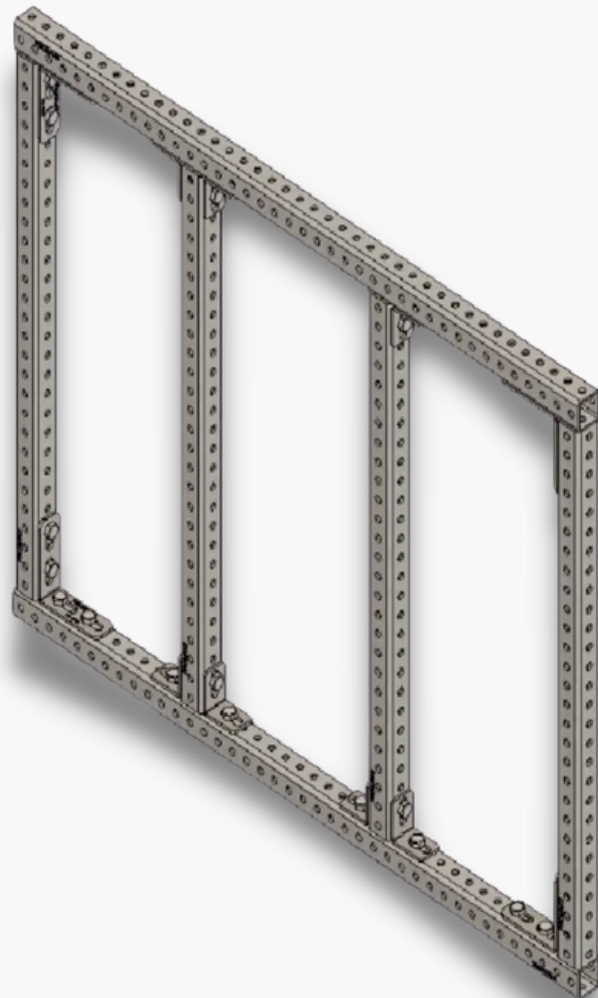
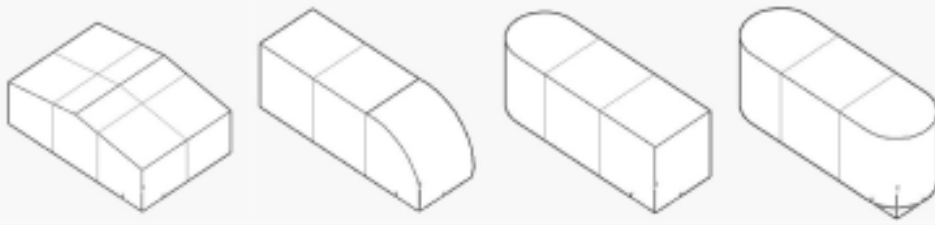
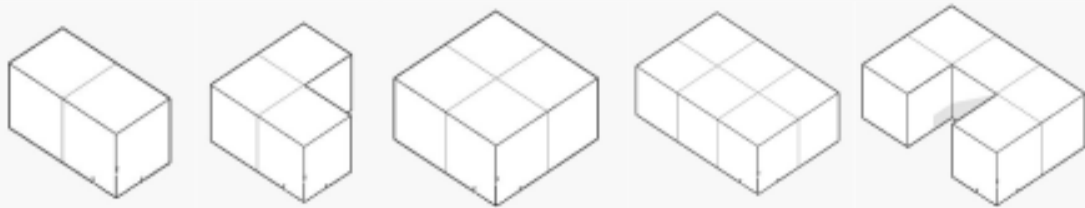

# V>EASY 50 Series

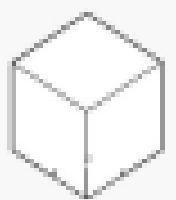
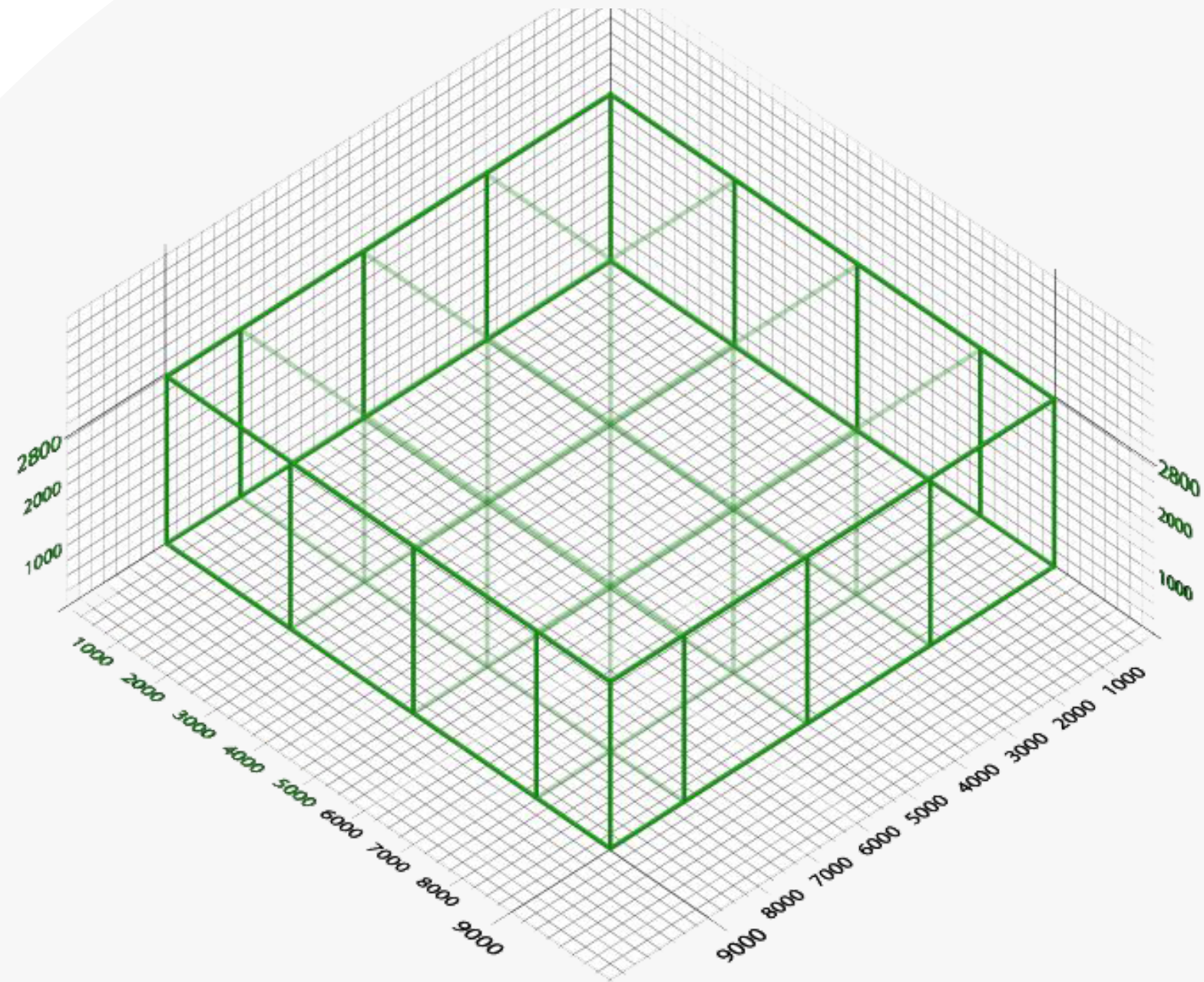

Base Module : 2.5 x 2.5 x 2.8 m



## Smart Connection



PMKS-KD-450  
Promega Connection

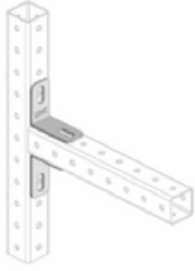

PMKS-KD-451  
Promega Connection

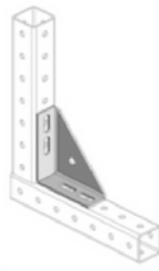

PMKS-KD-452  
Promega Connection



PMKS-MFS-040/050  
Promega Connection

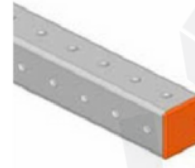

PMKS-PC-050  
Promega Connection



PMKS-TTA-040/050  
Promega Connection

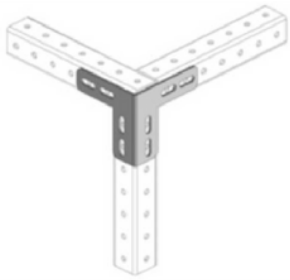

PMKS-TDE-040/050  
Promega Connection

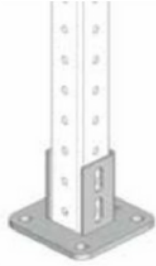

PMKS-TTA-041/051  
Promega Connection



PMKS-TTY-040/050  
Promega Connection



PMKS-TTY-041/051  
Promega Connection

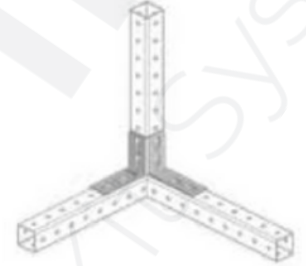

PMKS-TTY-042/052  
Promega Connection

## ProMAKS Profile

PMKS-PRF-050-001

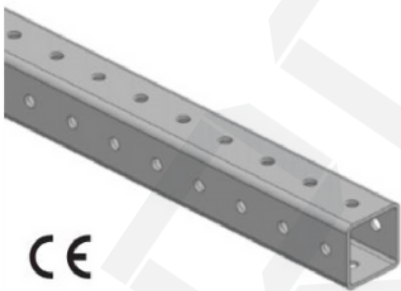

CE



Delik arası mesafe: 25 mm  
Delik çapı: 9,5 mm  
Distance between holes: 25 mm  
Hole diameter: 9,5 mm

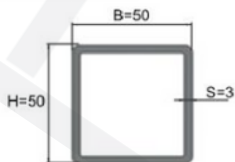

## Connection Pieces



PMKS-KD-450

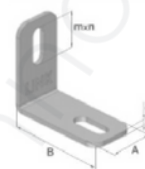

PMKS-KD-451

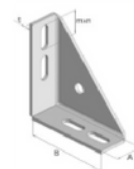

PMKS-KD-452



PMKS-MFS-040/050

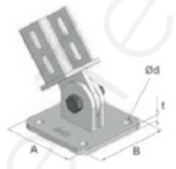

PMKS-KOD-100-001

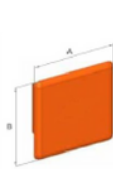

PMKS-PC-050

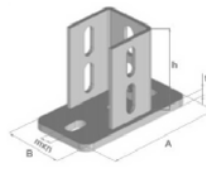

PMKS-TTA-040/050

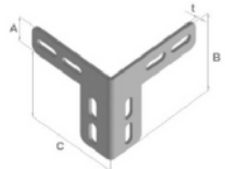

PMKS-TDE-040/050

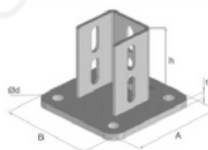

PMKS-TTA-041/051

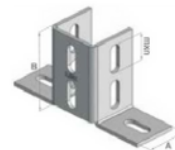

PMKS-TTY-040/050



PMKS-TTY-041/051

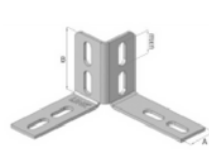

PMKS-TTY-042/052

# Medium Duty V-EASY Structural System

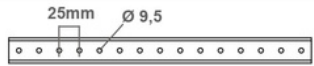
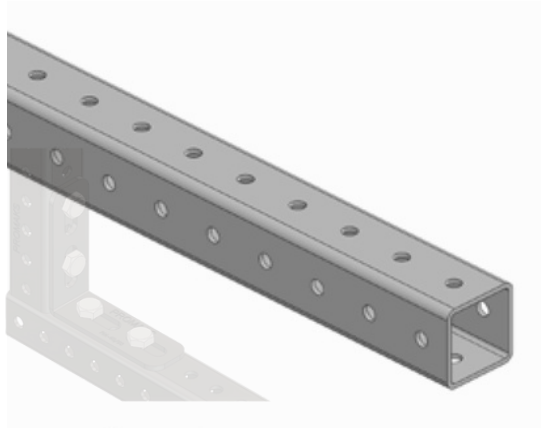

Distance between holes: 25 mm  
Hole diameter: 9,5 mm

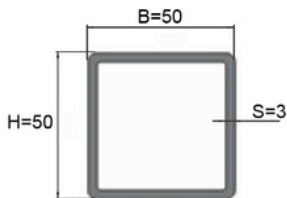

## Service

Promaks is modular kit structural system, provide easy installation with self-threading bolt and medium load capacity due to its special design.



## Materials and Type

Steel S235 JR

## Coating

EN 1461 Hot-dip galvanized 92µm minimum  
Hot-dip of galvanize.

## Section Properties

Profile Size			Unit Weight (kg)	Cross Section Area (mm <sup>2</sup> )	Torsional Section Modules (cm <sup>3</sup> )	Torsion Moment of Inertia (cm <sup>4</sup> )	Moment of Inertia (cm <sup>4</sup> )		Section Modules (cm <sup>3</sup> )	
H	B	S					I <sub>y</sub>	I <sub>z</sub>	W <sub>y</sub>	W <sub>z</sub>
50	50	3	4,00	432,00	13,19	33,07	16,53	16,53	6,61	6,61

The section properties is determined according to the perforated section.

### Distributed load

Lmax (mm)	qz, perm kN/m	Fz, (qz,perm *L) kN
1000	8,5	8,5
1500	2,7	4,05
2000	1,1	2,2
2500	0,56	1,4
3000	0,31	0,93
3500	0,19	0,665

qz[kN/m] as permanent load at L

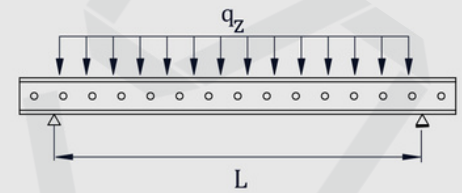

### Point load

Lmax (mm)	Fz, perm kN
1000	4,3
1500	2,6
2000	1,4
2500	0,91
3000	0,61
3500	0,39

Fz[kN] as permanent load at L/2

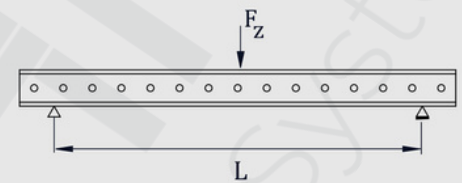

### 2 Point loads

Lmax (mm)	Fz, perm kN
1000	3,2
1500	1,5
2000	0,8
2500	0,52
3000	0,34
3500	0,24

Fz[kN] as permanent load at L/2 and 2\*L/3

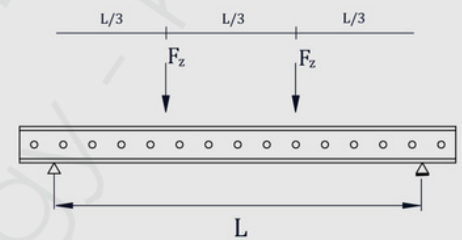

### 3 Point loads

Lmax (mm)	Fz, perm kN
1000	2,4
1500	1,1
2000	0,6
2500	0,35
3000	0,26
3500	0,17

Fz[kN] as permanent load at L/4, L/2 and 3\*L/4

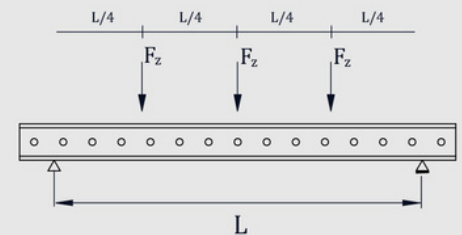

- Basis of calculation of the load capacity is accordance with Eurocode 3 (EN 1993)
- Self weight considered.
- Safety factor is taken into account as 1,35.
- Deflection limit value is L/200.

# V-CORE 80 Series

*design as you like...*

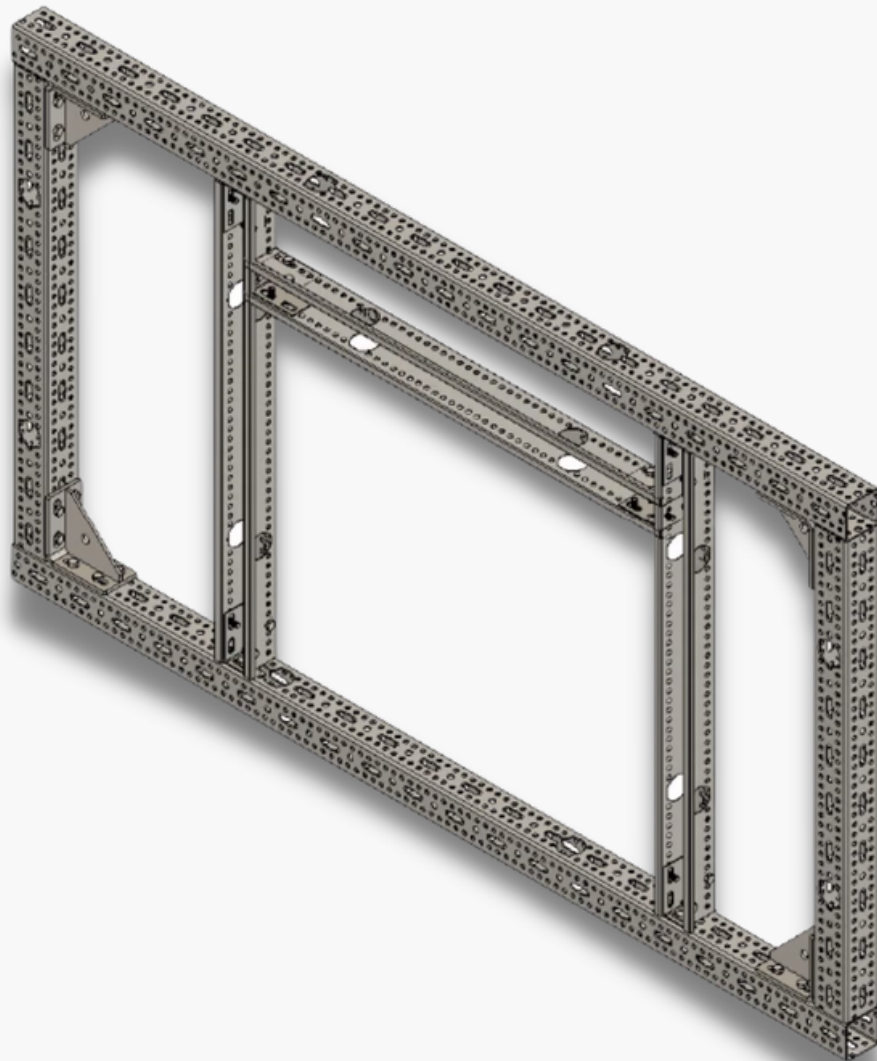
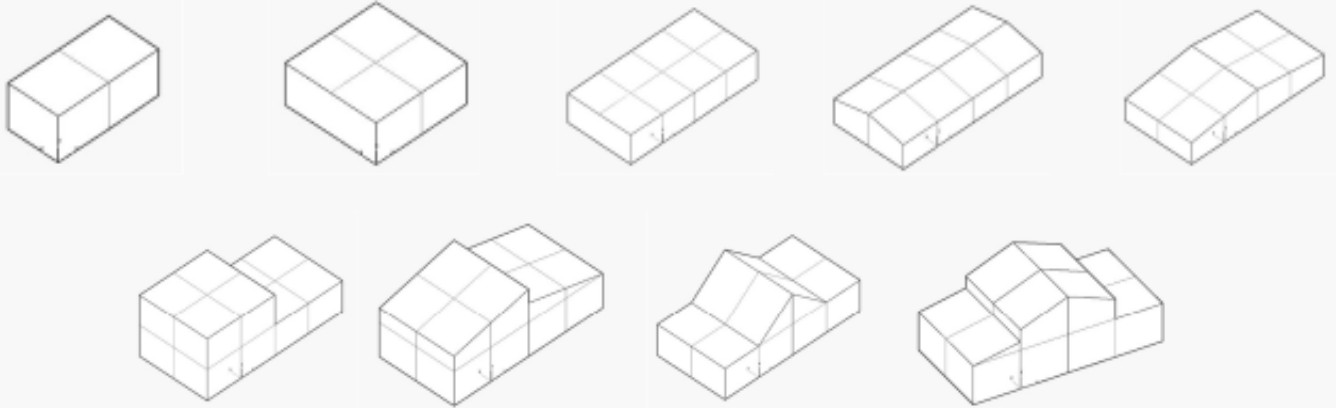

# V-CORE 80 Series

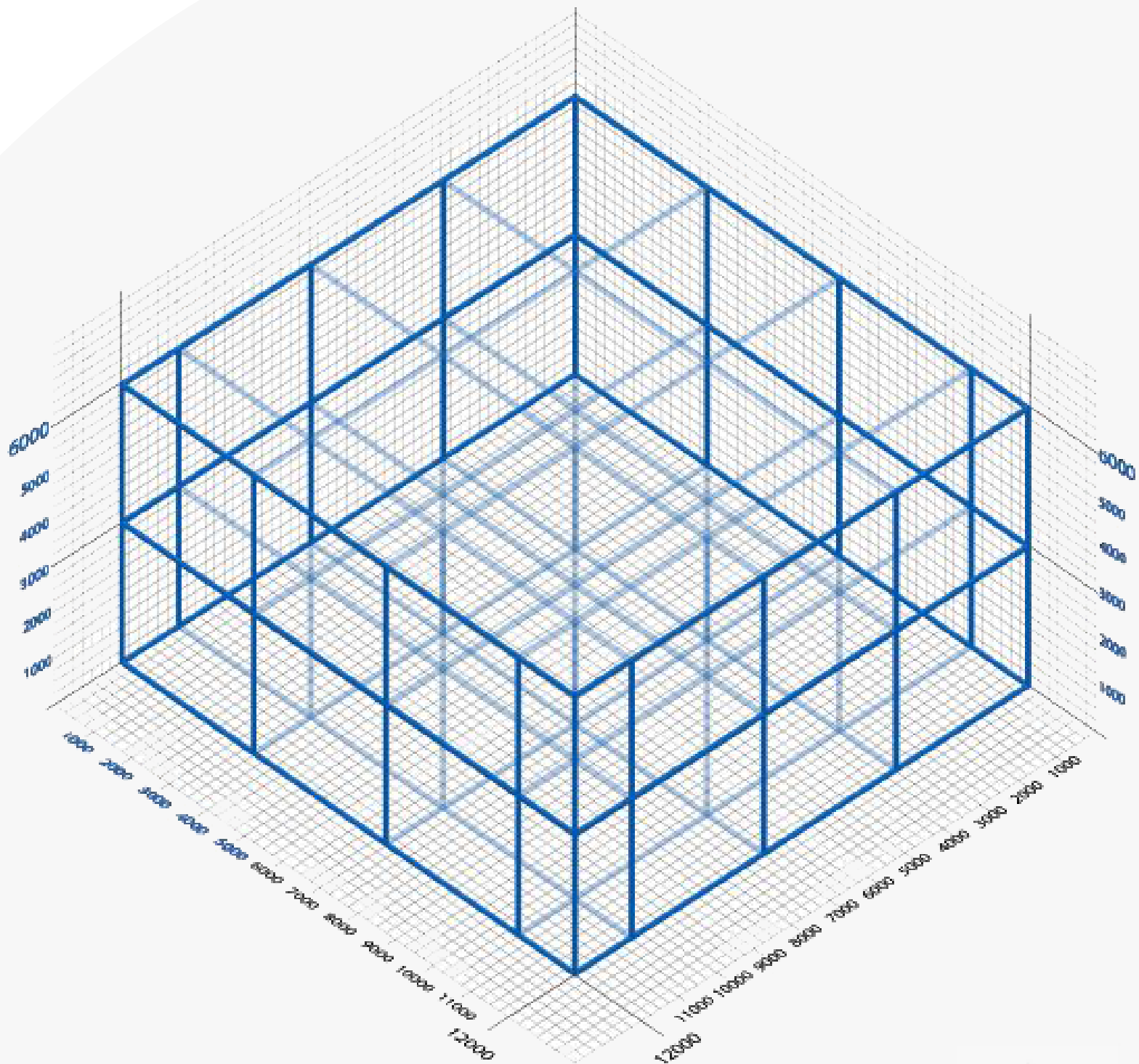

Base Module : 3.5 x 3.5 x 3.0 m

## Smart Connection

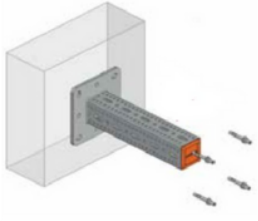

PMKS-HK-080  
Promega Connection



PMKS-KD-080  
Promega Connection



PMKS-KD-082  
Promega Connection



PMKS-HK-080  
-Promega-Promega  
Connection

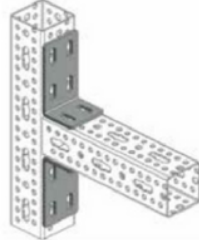

PMKS-KD-081  
Promega Connection



PMKS-KD-118  
Promega Connection



PMKS-TTA-080  
Promega Connection

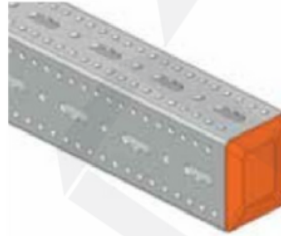

PMKS-PC-080  
Promega Connection



PMKS-MFS-080/081  
Promega Connection

## ProMAKS Profile

PMKS-PRF-080-001

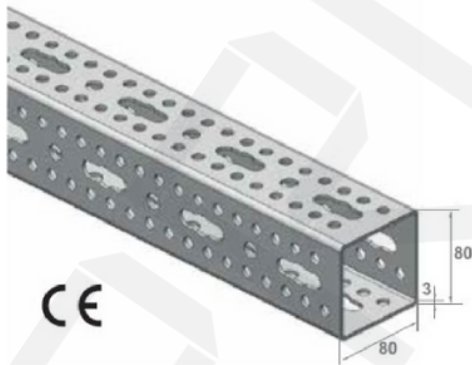

CE

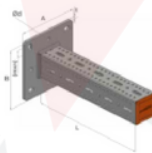
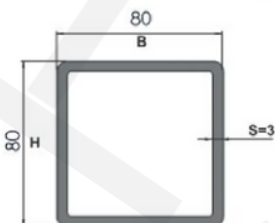

PMKS-HK-080

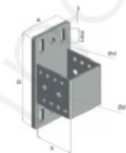

PMKS-KA-080

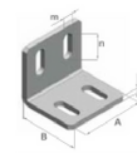

PMKS-KD-080

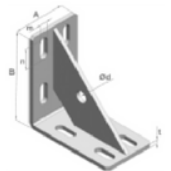

PMKS-KD-082



PMKS-KD-081

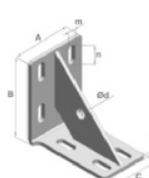

PMKS-KD-118



PMKS-PC-080

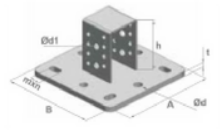

PMKS-TTA-080

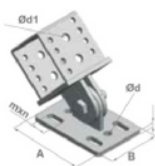

PMKS-MFS-080

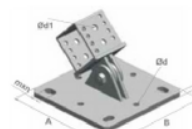

PMKS-MFS-081

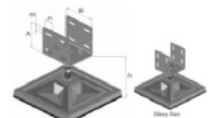

PMKS-FOOT-80/81

## Connection Pieces

# Heavy Duty V-CORE Series Structural System

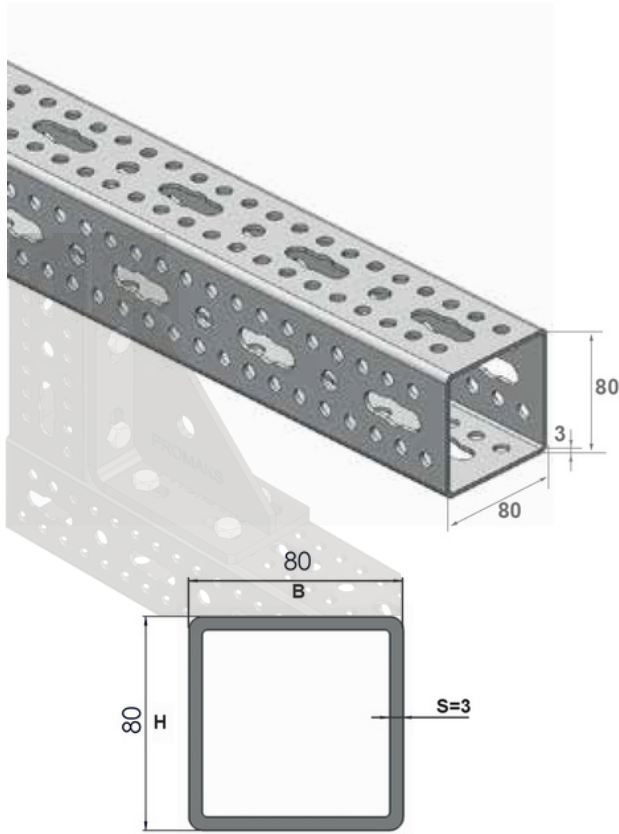

## Service

Promaks is modular kit structural system, provide easy installation with self-threading bolt and high load capacity due to its special design.



## Materials and Type

Steel S235 JR

## Coating

EN 1461 Hot-dip galvanized 92µm minimum Hot-dip of galvanize.

## Section Properties

Profile Size			Unit Weight (kg)	Cross Section Area (mm <sup>2</sup> )	Torsional Section Modules (cm <sup>3</sup> )	Torsion Moment of Inertia (cm <sup>4</sup> )	Moment of Inertia		Section Modules	
H	B	S					ly	lz	Wy	Wz
80	80	3	5,74	510,00	35,51	108,82	54,41	54,41	13,60	13,60

■ The section properties is determined according to the perforated section.

### Distributed load

Lmax (mm)	qz, perm kN/m	Fz, (qz,perm *L) kN
1000	18,00	18,00
1500	8,00	12,00
2000	3,82	7,64
2500	1,94	4,85
3000	1,10	3,30
3500	0,68	2,38

qz[kN/m] as permanent load at L

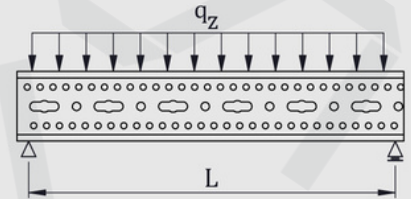

### Point load

Lmax (mm)	Fz, perm kN
1000	9,00
1500	6,00
2000	4,44
2500	3,14
3000	2,15
3500	1,54

Fz[kN] as permanent load at L/2

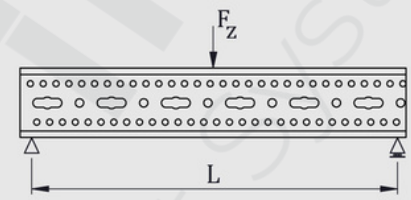

### 2 point loads

Lmax (mm)	Fz, perm kN
1000	6,83
1500	4,50
2000	2,82
2500	1,80
3000	1,21
3500	0,87

Fz[kN] as permanent load at L/2 and 2\*L/3

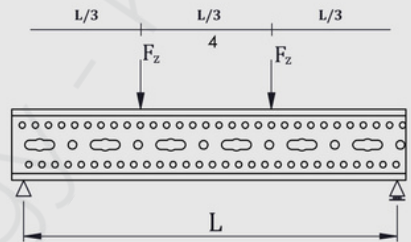

### 3 point loads

Lmax (mm)	Fz, perm kN
1000	4,50
1500	3,00
2000	2,00
2500	1,20
3000	0,87
3500	0,60

Fz[kN] as permanent load at L/4, L/2 and 3\*L/4

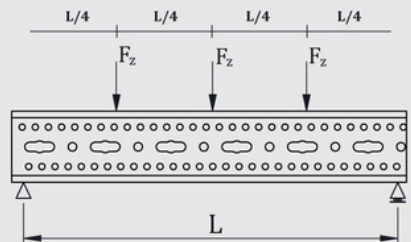

- Basis of calculation of the load capacity is accordance with Eurocode 3 (EN 1993)
- Self weight considered.
- Safety factor is taken into account as 1,35.
- Deflection limit value is L/200.

# V>LINE 100 Series

*design as you like...*

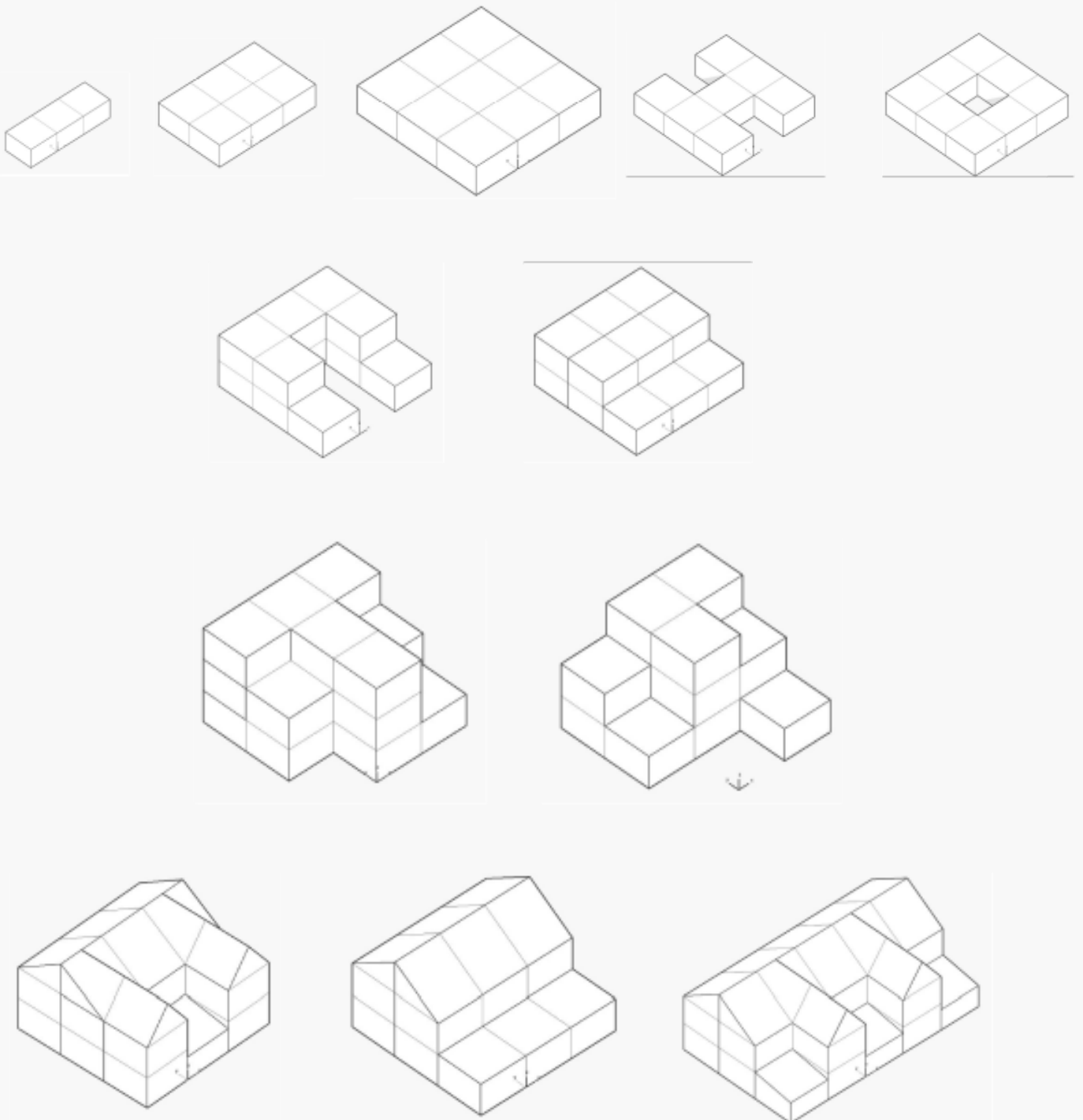

# VLINE 100 Series

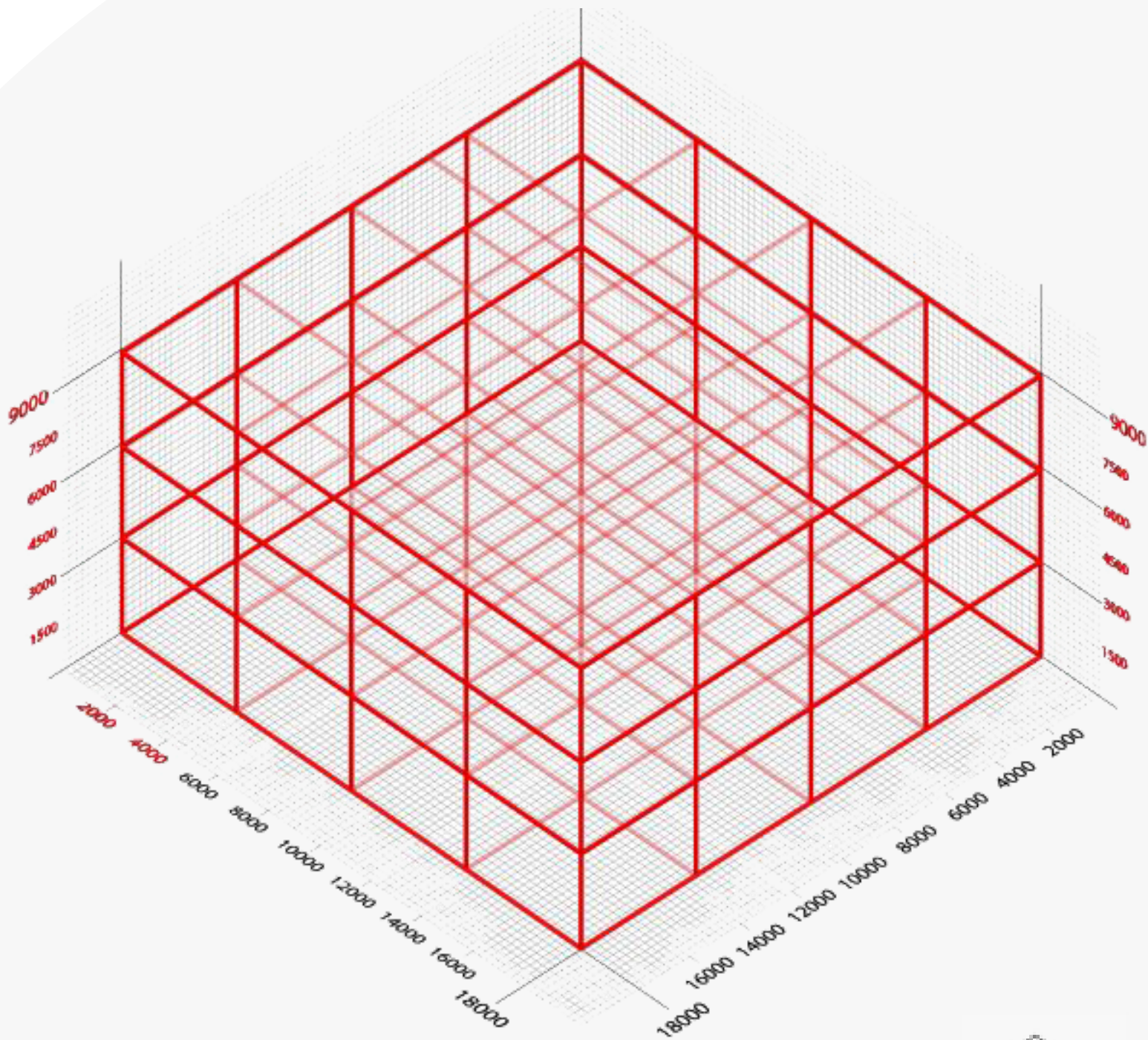

Base Module : 4.5 x 4.5 x 3.0 m



## Smart Connection

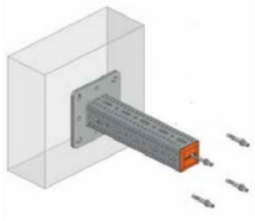

PMKS-HK-100  
Promega Connection



PMKS-KD-120  
Promega Connection



PMKS-KD-101  
Promega Connection



PMKS-HK-100  
-Promega-Promega  
Connection

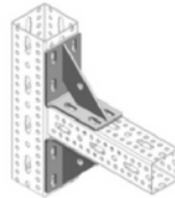

PMKS-KD-121  
Promega Connection



PMKS-foot-100/101  
Promega Connection



PMKS-TTA-100  
Promega Connection

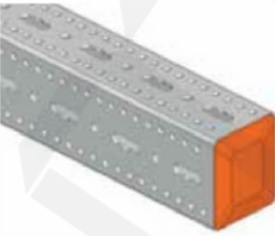

PMKS-PC-100  
Promega Connection



PMKS-MFS-100/101  
Promega Connection

## ProMAKS Profile

PMKS-PRF-100-001

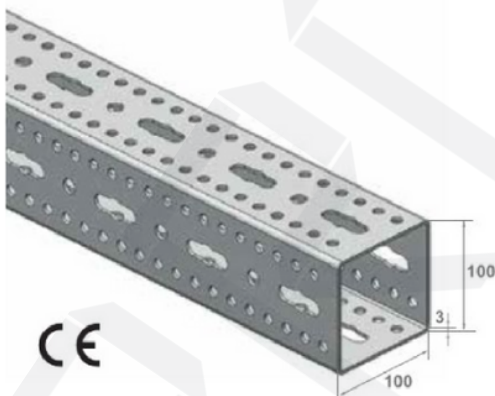

CE

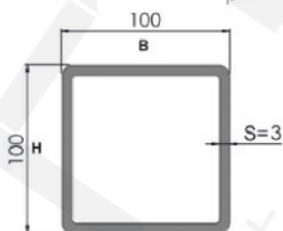

## Connection Pieces

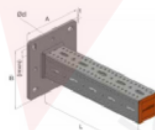

PMKS-HK-100

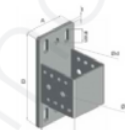

PMKS-KA-100

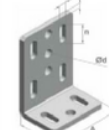

PMKS-KD-100

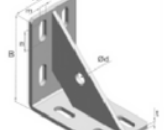

PMKS-KD-101

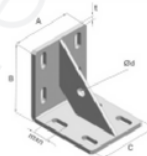

PMKS-KD-120

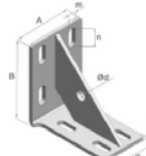

PMKS-KD-121

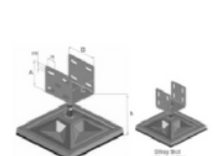

PMKS-FOOT-100/101

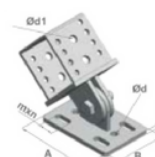

PMKS-MFS-100

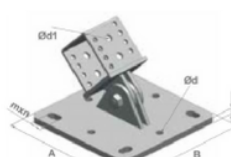

PMKS-MFS-101



PMKS-PC-100

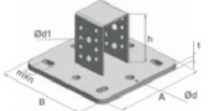

PMKS-TTA-100

# Heavy Duty V-LINE Series Structural System

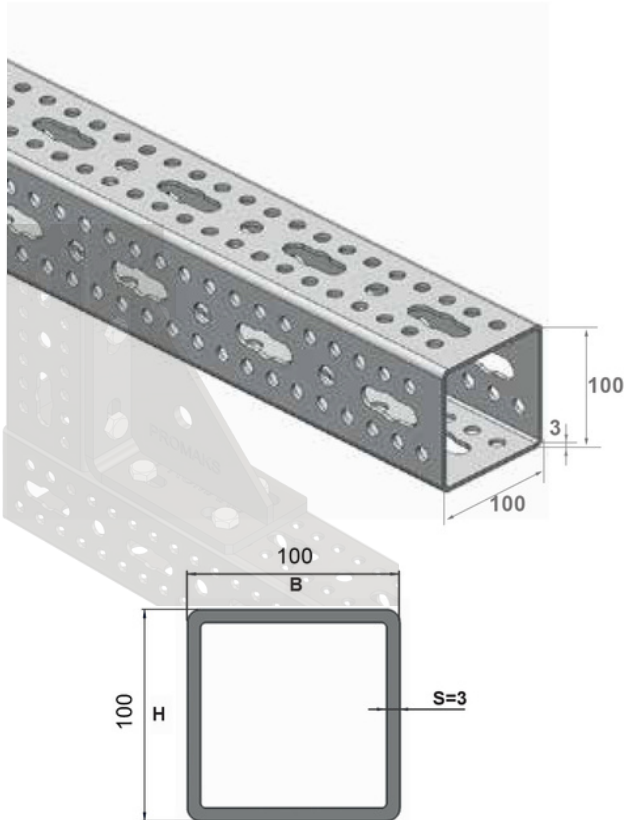

## Service

Promaks is modular kit structural system, provide easy installation with self-threading bolt and high load capacity due to its special design.

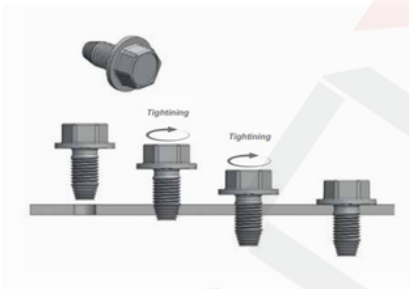

## Materials and Type

Steel S235 JR

## Coating

EN 1461 Hot-dip galvanized  
92µm minimum Hot-dip of galvanize.

## Section Properties

Profile Size			Unit Weight (kg)	Cross Section Area (mm <sup>2</sup> )	Torsional Section Modulus (cm <sup>3</sup> )	Torsion Moment of Inertia (cm <sup>4</sup> )	Moment of Inertia (cm <sup>4</sup> )		Section Modulus (cm <sup>3</sup> )	
H	B	S					I <sub>y</sub>	I <sub>z</sub>	W <sub>y</sub>	W <sub>z</sub>
100	100	3	7,3	750,00	56,39	242,23	121,12	121,12	24,22	24,22

The section properties is determined according to the perforated section.

### Distributed load

Lmax (mm)	qz, perm kN/m	Fz,(qz,perm *L) kN
1000	32,00	32,00
2000	8,00	16,00
3000	2,51	7,53
4000	1,03	4,12
5000	0,50	2,50
6000	0,26	1,56

qz[kN/m] as permanent load at L

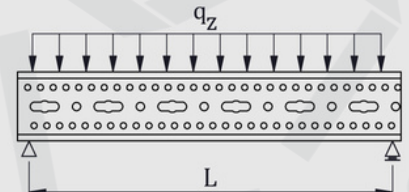

### Point load

Lmax (mm)	Fz, perm kN
1000	16,00
2000	7,90
3000	4,70
4000	2,50
5000	1,50
6000	0,99

Fz[kN] as permanent load at L/2

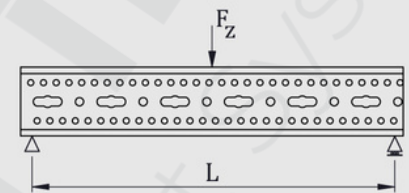

### 2 point loads

Lmax (mm)	Fz, perm kN
1000	12,00
2000	5,90
3000	2,71
4000	1,52
5000	0,91
6000	0,58

Fz[kN] as permanent load at L/2 and 2\*L/3

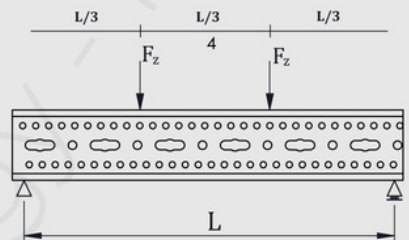

### 3 point loads

Lmax (mm)	Fz, perm kN
1000	8,00
2000	3,90
3000	1,96
4000	1,10
5000	0,65
6000	0,40

Fz[kN] as permanent load at L/4, L/2 and 3\*L/4

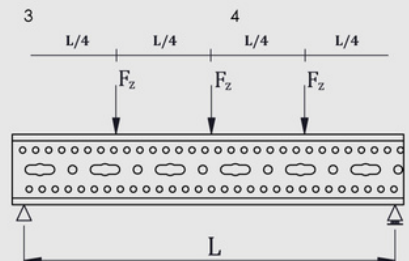

- Basis of calculation of the load capacity is accordance with Eurocode 3 (EN 1993)
- Self weight considered.
- Safety factor is taken into account as 1,35.
- Deflection limit value is L/200.

# V-KING 120 Series

*design as you like...*

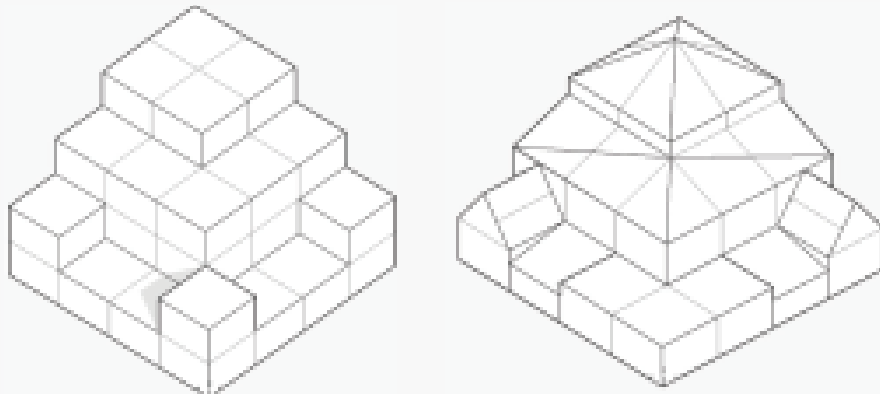
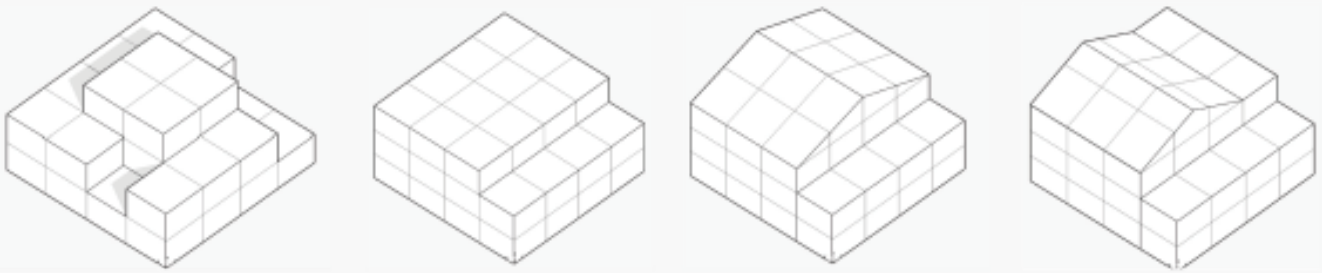
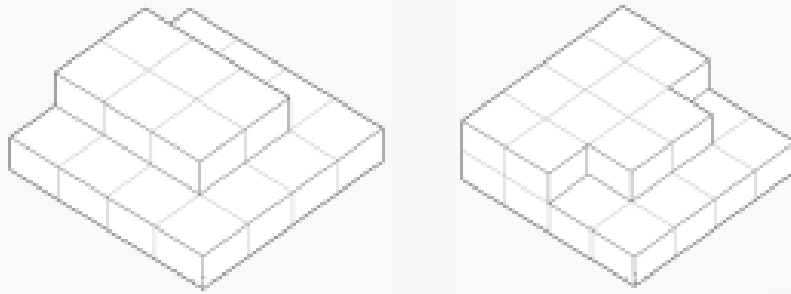
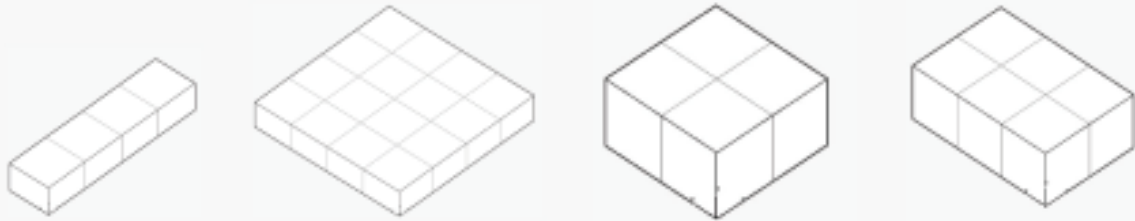

# V-KING 120 Series

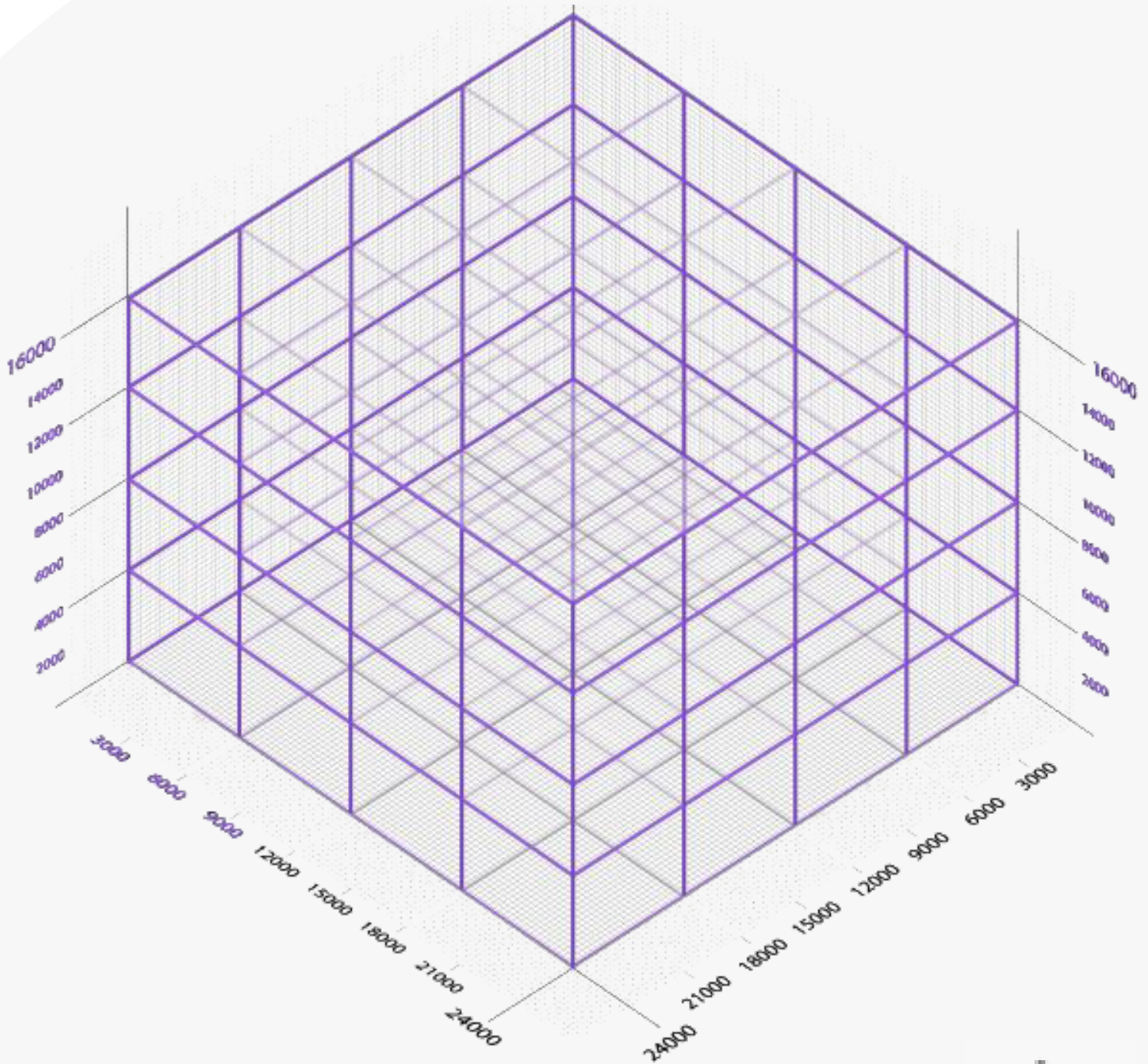

Base Module : 6.0 x 6.0 x 4.0 m

# Smart Connection

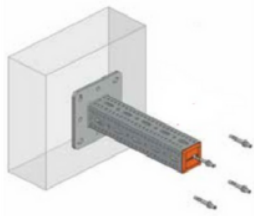

PMKS-HK-120  
Promega Connection

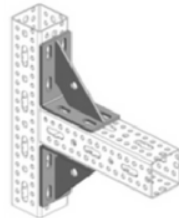

PMKS-KD-120  
Promega Connection



PMKS-KD-101  
Promega Connection



PMKS-HK-120  
-Promega-Promega  
Connection



PMKS-KD-121  
Promega Connection



PMKS-foot-120/121  
Promega Connection



PMKS-TTA-120  
Promega Connection

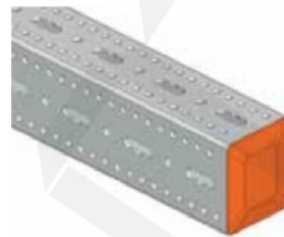

PMKS-PC-120  
Promega Connection



PMKS-MFS-120/121  
Promega Connection

# ProMAKS Profile

PMKS-PRF-120-001

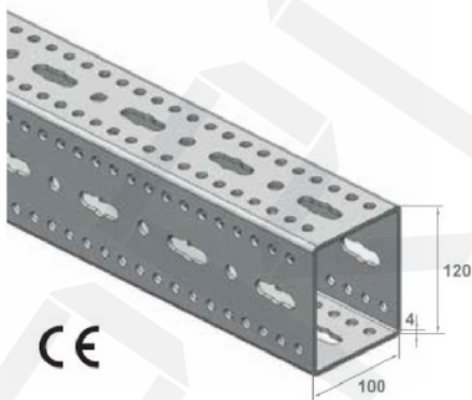

CE

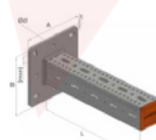
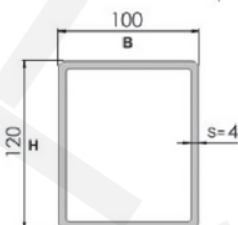

PMKS-HK-120

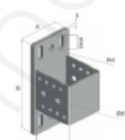

PMKS-KA-120

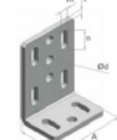

PMKS-KD-100

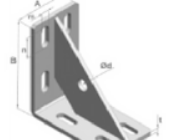

PMKS-KD-101

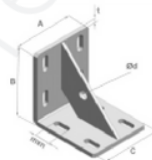

PMKS-KD-120

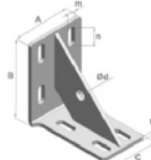

PMKS-KD-121

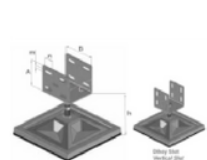

PMKS-FOOT-120/121

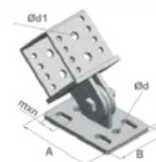

PMKS-MFS-120

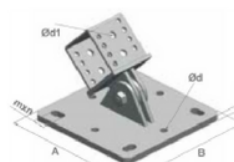

PMKS-MFS-121



PMKS-PC-120

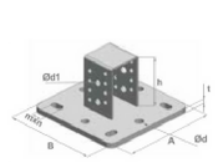

PMKS-TTA-120

# Connection Pieces

# Heavy Duty V-KING Series Structural System

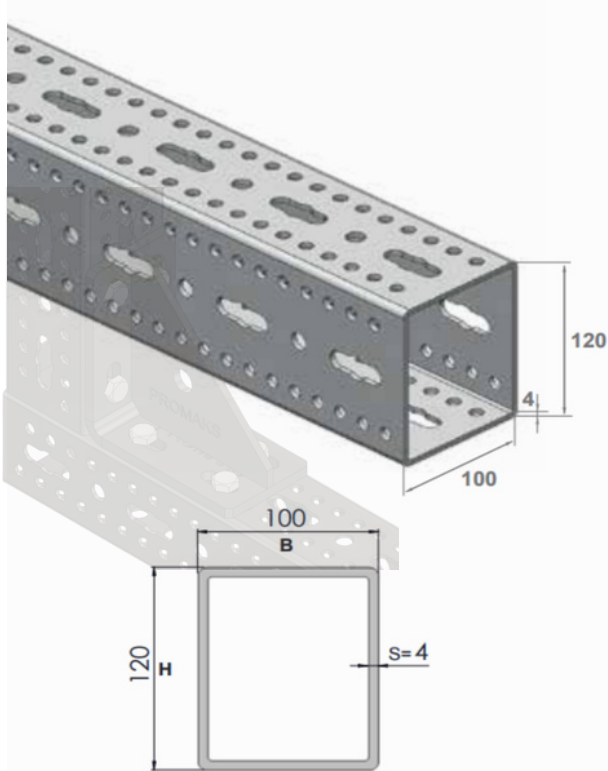

## Service

Promaks is modular kit structural system, provide easy installation with self-threading bolt and high load capacity due to its special design.

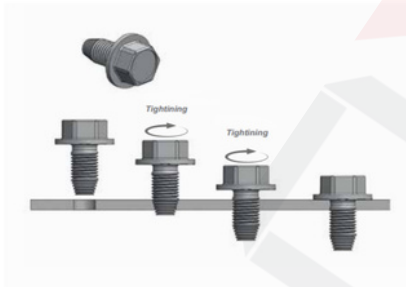

## Materials and Type

Steel S235 JR

## Coating

EN 1461 Hot-dip galvanized  
92µm minimum Hot-dip of galvanize.

## Section Properties

Profile Size			Unit Weight (kg)	Cross Section Area (mm <sup>2</sup> )	Torsional Section Modules (cm <sup>3</sup> )	Torsion Moment of Inertia (cm <sup>4</sup> )	Moment of Inertia		Section Modules	
H	B	S					ly	lz	Wy	Wz
120	100	4	11	1147,00	89,02	435,10	241,92	193,18	40,32	38,64

■ The section properties is determined according to the perforated section.

### Distributed load

Lmax (mm)	qz, perm kN/m	Fz,(qz,perm *L) kN
1000	53,00	53,00
2000	13,30	26,60
3000	4,70	14,10
4000	2,00	8,00
5000	0,95	4,75
6000	0,54	3,24

qz[kN/m] as permanent load at L

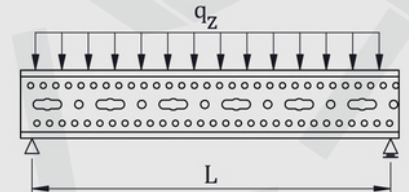

### Point load

Lmax (mm)	Fz, perm kN
1000	26,00
2000	13,30
3000	8,08
4000	5,20
5000	3,20
6000	2,10

Fz[kN] as permanent load at L/2

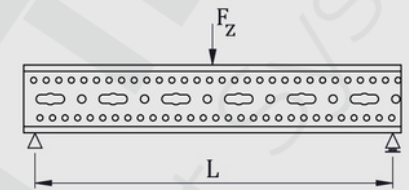

### 2 point loads

Lmax (mm)	Fz, perm kN
1000	20,00
2000	9,90
3000	5,50
4000	3,00
5000	1,80
6000	1,20

Fz[kN] as permanent load at L/2 and 2\*L/3

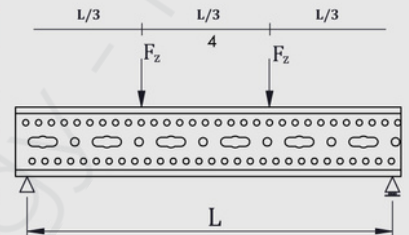

### 3 point loads

Lmax (mm)	Fz, perm kN
1000	13,40
2000	6,60
3000	3,90
4000	2,20
5000	1,30
6000	0,86

Fz[kN] as permanent load at L/4, L/2 and 3\*L/4

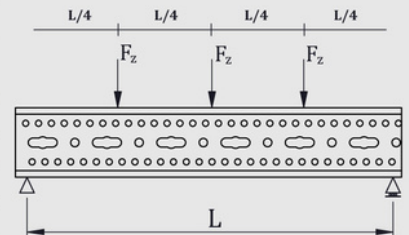

- Basis of calculation of the load capacity is accordance with Eurocode 3 (EN 1993)
- Self weight considered.
- Safety factor is taken into account as 1,35.
- Deflection limit value is L/200.

# V>GIANT 150 Series

*design as you like...*

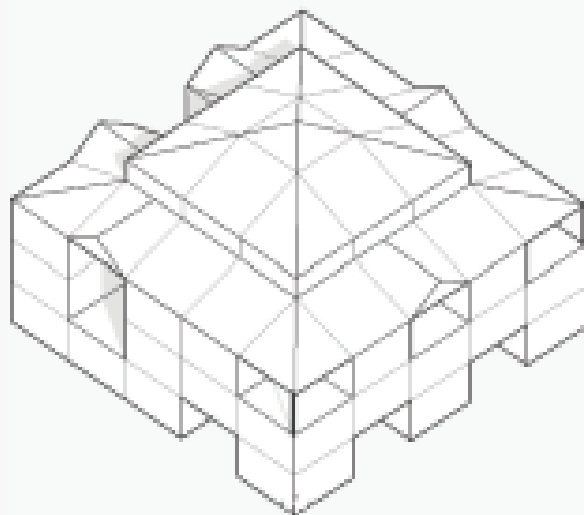
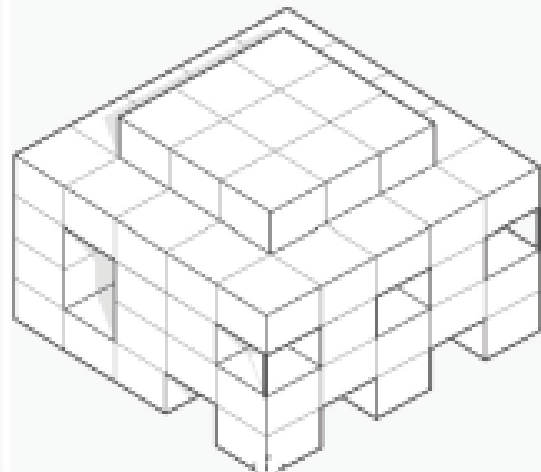
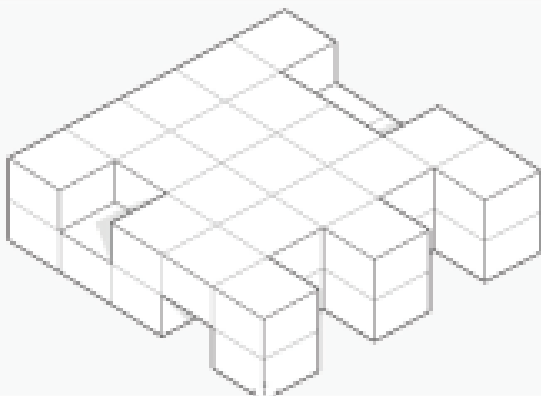
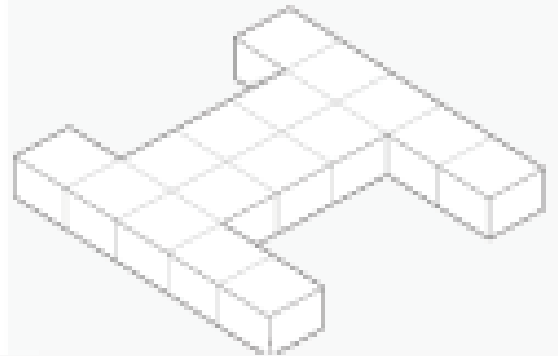
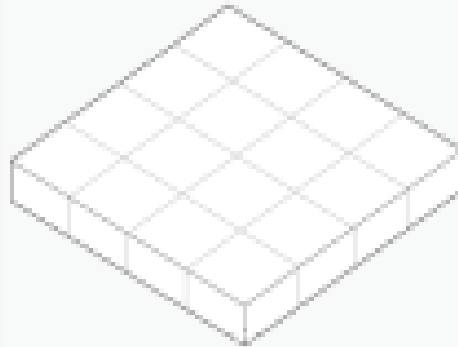
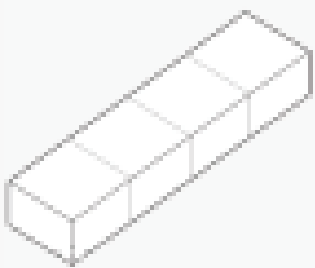

# V>GIANT 150 Series

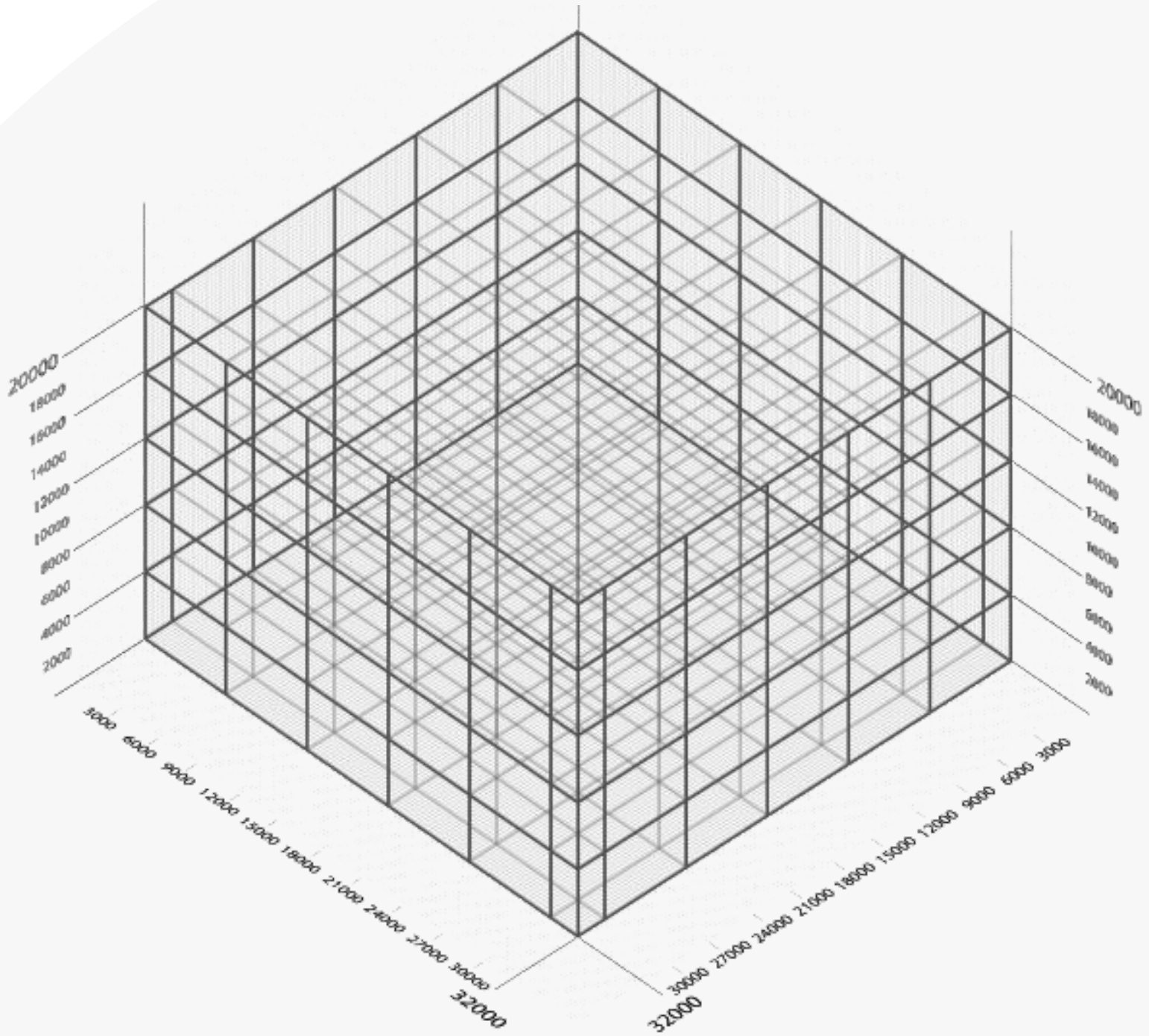

Base Module : 6.0 x 6.0 x 4.0 m



## Smart Connection

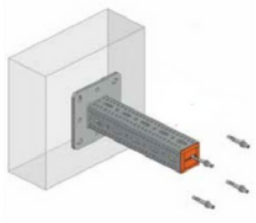

PMKS-HK-150  
Promega Connection

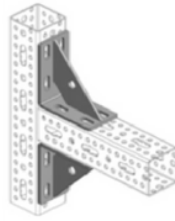

PMKS-KD-120  
Promega Connection



PMKS-KD-101  
Promega Connection



PMKS-HK-150  
-Promega-Promega  
Connection



PMKS-KD-121  
Promega Connection



PMKS-foot-150/151  
Promega Connection



PMKS-TTA-150  
Promega Connection

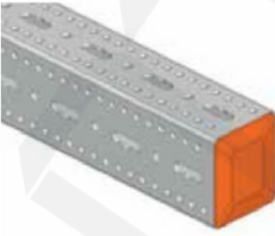

PMKS-PC-150  
Promega Connection



PMKS-MFS-150/151  
Promega Connection

## ProMAKS Profile

PMKS-PRF-150-001

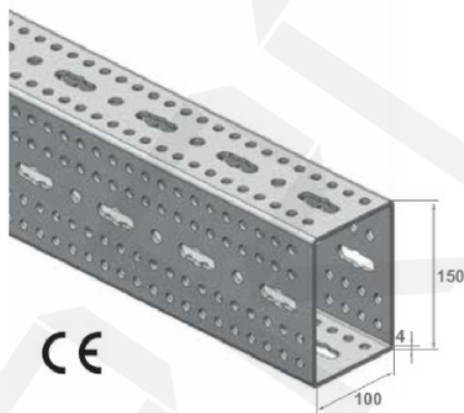

CE

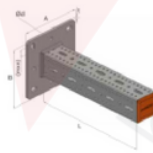
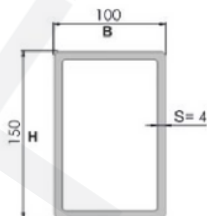

PMKS-HK-150

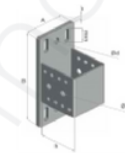

PMKS-KA-120

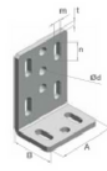

PMKS-KD-100

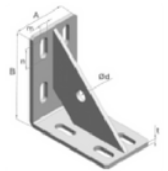

PMKS-KD-101

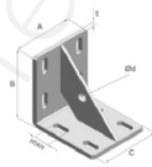

PMKS-KD-120

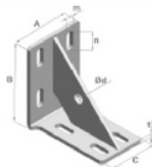

PMKS-KD-121

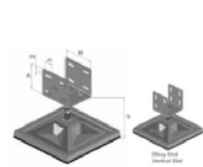

PMKS-FOOT-150/151

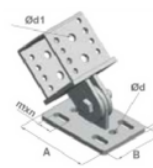

PMKS-MFS-150

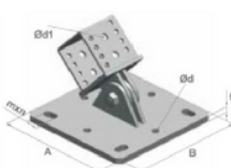

PMKS-MFS-151



PMKS-PC-150

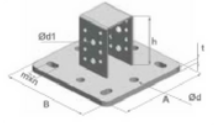

PMKS-TTA-150

## Connection Pieces

# Heavy Duty V-GIANT Series Structural System

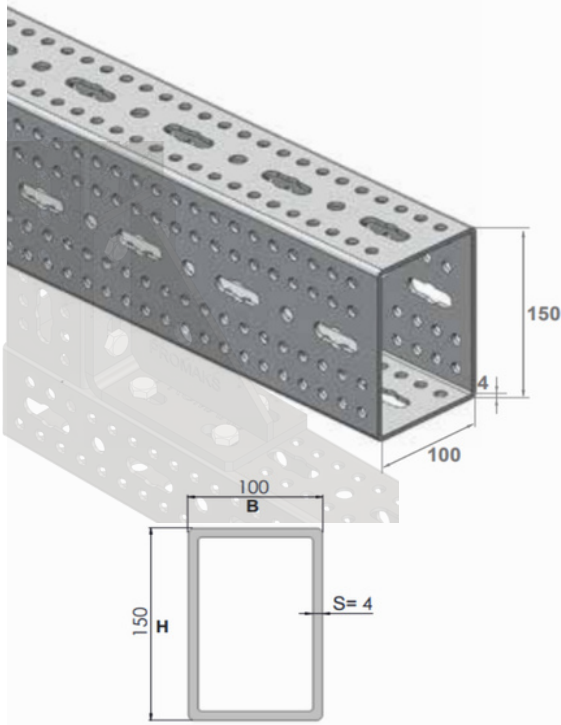

## Service

Promaks is modular kit structural system, provide easy installation with self-threading bolt and high load capacity due to its special design.

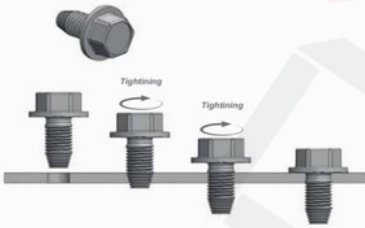

## Materials and Type

Steel S235 JR

## Coating

EN 1461 Hot-dip galvanized  
92µm minimum Hot-dip of galvanize.

## Section Properties

Profile Size			Unit Weight (kg)	Cross Section Area (mm <sup>2</sup> )	Torsional Section Modules (cm <sup>3</sup> )	Torsion Moment of Inertia (cm <sup>4</sup> )	Moment of Inertia (cm <sup>4</sup> )		Section Modules (cm <sup>3</sup> )	
H	B	S					I <sub>y</sub>	I <sub>z</sub>	W <sub>y</sub>	W <sub>z</sub>
150	100	4	12	1235,00	112,06	618,26	404,80	213,46	53,97	42,69

■ The section properties is determined according to the perforated section.

### Distributed load

Lmax (mm)	q <sub>z</sub> , perm kN/m	F <sub>z</sub> , (q <sub>z</sub> , perm *L) kN
1000	71,00	71,00
2000	17,80	35,60
3000	7,90	23,70
4000	3,50	14,00
5000	1,75	8,75
6000	0,97	5,82

q<sub>z</sub>[kN/m] as permanent load at L

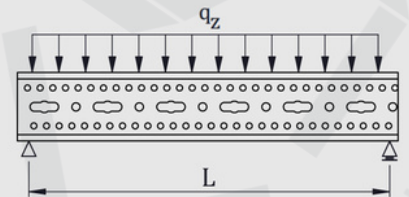

### Point load

Lmax (mm)	F <sub>z</sub> , perm kN
1000	35,30
2000	17,80
3000	11,60
4000	8,70
5000	5,40
6000	3,60

F<sub>z</sub>[kN] as permanent load at L/2

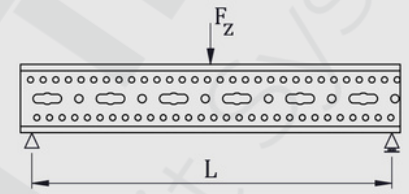

### 2 point loads

Lmax (mm)	F <sub>z</sub> , perm kN
1000	26,00
2000	13,30
3000	8,80
4000	5,20
5000	3,10
6000	2,10

F<sub>z</sub>[kN] as permanent load at L/2 and 2\*L/3

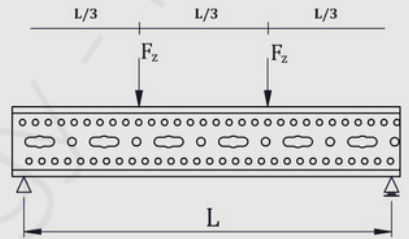

### 3 point loads

Lmax (mm)	F <sub>z</sub> , perm kN
1000	17,90
2000	8,90
3000	5,90
4000	3,60
5000	2,30
6000	1,50

F<sub>z</sub>[kN] as permanent load at L/4, L/2 and 3\*L/4

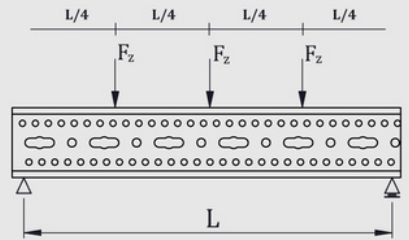

- Basis of calculation of the load capacity is accordance with Eurocode 3 (EN 1993)
- Self weight considered.
- Safety factor is taken into account as 1,35.
- Deflection limit value is L/200.

# WINDOWS DOORS

ProMAKS system flexibility allows for late stage design changes even on the construction site

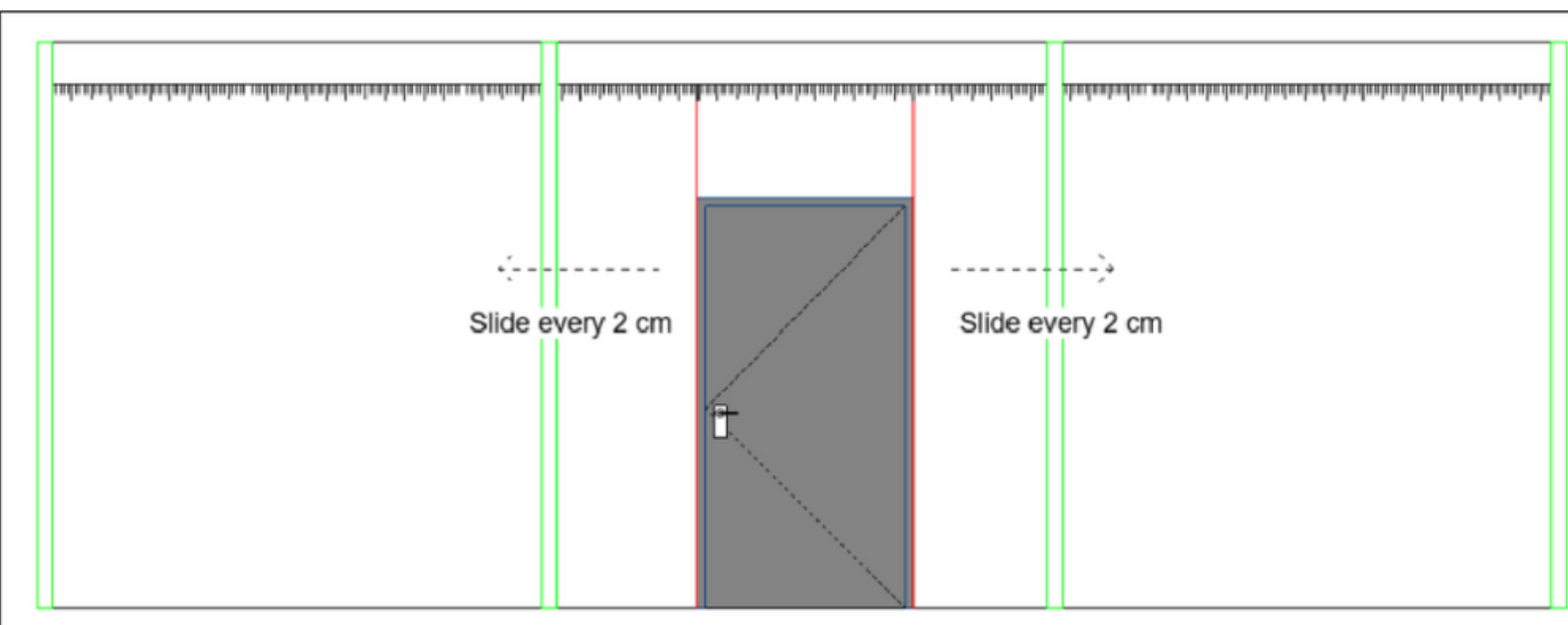
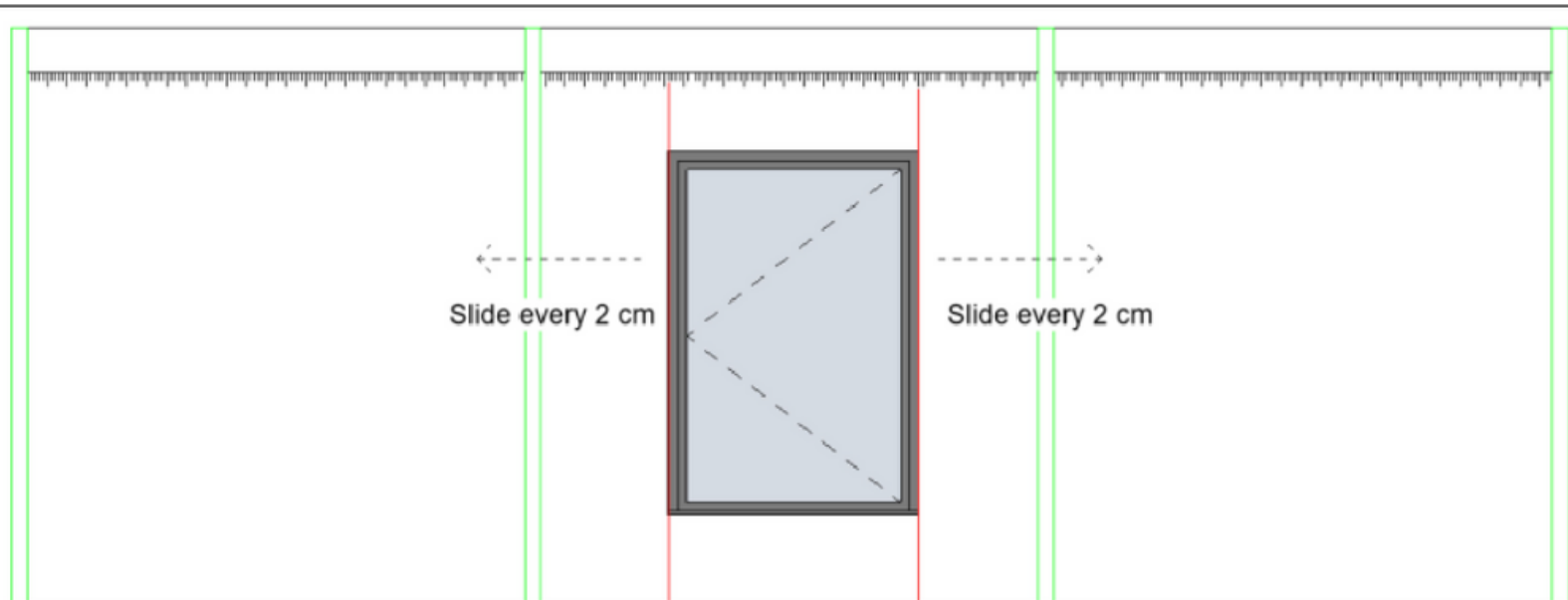

ZERTIFIKAT | CERTIFICATE | CERTIFICADO | CERTIFICAZIONE | CERTIFICAZIONE



## CERTIFICATE

of conformity  
of the factory production control

No.: 0408-CPR-TA3643

In compliance with Regulation 305/2011/EU of the European Parliament and of the Council of 9<sup>th</sup> March 2011 ( the Construction Products Regulation or CPR), this certificate applies to the construction product:

**Components for Steel structures**

harmonized Standard	execution class	declaration method
EN 1090-1:2009+A1:2011	Load bearing steel components with corrosion protection up to EXC 2 acc. EN 1090-2	1 and 3a acc. Tab. A.1 of EN 1090-1

produced by or for  
**LINK YAPI SANAYI VE TICARET ANONIM SİRKETİ  
GEBZE ORGANİZE SANAYİ BÖLGESİ 1000.SK NO:1016  
ÇAYIROVA, KOCELI / TÜRKİYE**

and produced in the manufacturing plant (s)  
**LINK YAPI SANAYI VE TICARET ANONIM SİRKETİ  
GEBZE ORGANİZE SANAYİ BÖLGESİ 1000.SK NO:1016  
ÇAYIROVA, KOCELI / TÜRKİYE**

This certificate attests that all provisions concerning the assessment and verification of constancy of performance described in Annex ZA of the standard (s)

**EN 1090-1:2009+A1:2011**

under system 2+ are applied and that  
**the factory production control fulfills all the prescribed requirements set out above.**

This certificate was first issued on **28.07.2020** and will remain valid as long as the test methods and/or factory production control requirements included in the harmonized standard, used to assess the performance of the declared characteristics, do not change and the product, and the manufacturing conditions in the plant are not modified significantly. The next surveillance is due on **27.07.2023**.

Leonding 02.08.2022

PLACE DATE

  
 Maslak Alexander  
 CERTIFICATION BODY

  
 TUV AUSTRIA  
 SERVICES GMBH  
 Deutschstraße 10  
 A-1230 Wien



ZERTIFIKAT | CERTIFICATE | CERTIFICADO | CERTIFICAZIONE | CERTIFICAZIONE



## WELDING CERTIFICATE

Certificate No.: 0408-CPR-TA3643

**Manufacturer**  
LINK YAPI SANAYI VE TICARET ANONIM SİRKETİ  
GEBZE ORGANİZE SANAYİ BÖLGESİ 1000.SK NO:1016  
ÇAYIROVA, KOCELI / TÜRKİYE

**Factories**  
LINK YAPI SANAYI VE TICARET ANONIM SİRKETİ  
GEBZE ORGANİZE SANAYİ BÖLGESİ 1000.SK NO:1016  
ÇAYIROVA, KOCELI / TÜRKİYE

**Standard**  
EN 1090-1:2009+A1:2011  
EN 1090-2:2018

**Execution Classes**  
Up to EXC 2

**Welding Processes**  
(According to ISO 4063)  
135 – Metal Active Gas Welding  
212 – Resistance Spot Welding  
741 – Induction Welding

**Parent Metals**  
Group 1.1 and 1.2 acc. to CEN ISO/TR 15608 and EN 1090-2, Table 2 and 3  
Group 8.1 acc. to CEN ISO/TR 15608 and EN 1090-2, Table 4

**Responsible Welding Coordinator**  
Balhan LINCU (IWE), 17/09/1993  
Level (C) acc. to EN 1090-2, 7.4.3

**Deputies**  
–

**Confirmation**  
It is confirmed that all procedures for the execution and supervision of welding work are available.

**Remarks**  
This welding certificate is only valid within the scope of and in connection with FPC Certificate No.: 0408-CPR-TA3643

**Valid from**  
28.07.2020 (first day of issue)

**Next Surveillance**  
27.07.2023

Leonding 02.08.2022

PLACE DATE

  
 Maslak Alexander  
 CERTIFICATION BODY

  
 TUV AUSTRIA  
 SERVICES GMBH  
 Deutschstraße 10  
 A-1230 Wien



**ДОБРОВОЛЬНАЯ СЕРТИФИКАЦИЯ ПРОДУКЦИИ**

Система добровольной сертификации в области промышленной и сельскохозяйственной деятельности "СвирьТест" в составе "СвирьТест" Федеральное агентство по техническому регулированию и метрологии 11.04.2016 г.  
регистрационный № РОСС RU.1485.04НД000.101

**СЕРТИФИКАТ СООТВЕТСТВИЯ**

№ 04НД0101.ТРС.01160

Срок действия с 23.08.2021 по 22.08.2024

№ 1301485

**ОРГАН ПО СЕРТИФИКАЦИИ** Общество с ограниченной ответственностью «СвирьТест», Место нахождения (адрес юридического лица): 443030, РОССИЯ, Самарская область, город Самара, улица Урицкого, дом 19. Адрес места осуществления деятельности: 443030, РОССИЯ, Самарская область, Железнодорожный район, город Самара, улица Урицкого, дом 19, комнаты 45, 46, 48, 49. Телефон: +7(846)230-03-79. Адрес электронной почты: info@svirtest.ru. Свидетельство о государственной аккредитации органа по сертификации № РОСС RU.1485.04НД000.101 от 20.05.2021 года

**ПРОДУКЦИЯ** Крепежные изделия для монтажных работ, городской марки «LINK», «ФромМед»

Сертификат выдан

**СООТВЕТСТВУЕТ ТРЕБОВАНИЯМ НОРМАТИВНЫХ ДОКУМЕНТОВ** Стандарты изготовителя

**ИЗГОТОВИТЕЛЬ** «LINK YAPI SANAYI VE TICARET A.Ş.» Юридический адрес: Gebze OSB Mahallesi 1000, Cadde No:1016/1 Çayirova Köyü/Türkiye

**СЕРТИФИКАТ ВЫДАН** Обществу с ограниченной ответственностью «Мир Технологии» Юридический адрес: 117041, город Москва, улица Алавердан Рувкина, дом 4, этаж 6, помещение IV, офис 613. Телефон: 74954814150. E-mail: MirTechnology@gmail.com. ИНН: 7727360710

**НА ОСНОВАНИИ** Протокола испытаний № 195-21-08 от 20.08.2021 года, выданного испытательным центром Электротехнический завод «СтройМонтаж» Закрытого акционерного общества Науко-производственный центр «СТРОЙМОНТАЖ»

**ДОПОЛНИТЕЛЬНАЯ ИНФОРМАЦИЯ** Схема сертификации: К

  
 Руководитель органа  
 Эксперт

  
 И.В. Давыдов  
 начальник филиала  
 Ф.Ю. Яковлев  
 начальник филиала





**FM  
APPROVED**

## Certificate of Compliance

This certificate is issued for the following:

### Seismic Sway Brace Components for Pipe, Tubing and Conduit

(see details attached)

**Prepared for:**

Link Yapi Sanayi Ve Ticaret AS  
Gebze Organize Sanayi Bolgesi 1000  
Sokak No 1016  
Çayirova, Kocaeli 41400  
Turkey

**Manufactured at:**

Link Yapi Sanayi Ve Ticaret AS  
Gebze Organize Sanayi Bolgesi 1000  
Sokak No 1016  
Çayirova, Kocaeli 41400  
Turkey

FM Approvals Class: 1950 (September 2013)

Approval Identification: 0003062495      Approval Granted: November 12, 2019

To verify the availability of the Approved product, please refer to [www.approvalguide.com](http://www.approvalguide.com)

Said Approval is subject to satisfactory field performance, continuing Surveillance Audits, and strict conformity to the constructions as shown in the Approval Guide, an online resource of FM Approvals.

  
 David Fuller  
 VP - Manager of Fire Protection  
 FM Approvals  
 1151 Boston-Providence Turnpike  
 Norwood, MA 02062



FM Approvals®

Member of the FM Global Group

**TÜV NORD TURKEY Industrial Services**  
**Inspection Report**

INSPECTOR	Özgin Ozan TÜRK	TÜV ORDER NO.	211445326
PLACE & DATE	İTÜ Kompozit ve Yapı Lab.-03.12.2019	REPORT NO	RP-211445326-03
CUSTOMER	Link Yapı San. ve Tic. A.Ş.	MANUFACTURER	N/A
CUSTOMER ORDER NO	-	MANUFACTURER ORDER NO	-
INSPECTION DATES	03.12.2019	MANUFACTURER CONTACT	-
CUSTOMER CONTACTS	Ömer Çelöz	HARD STAMP	<input type="checkbox"/> Yes <input checked="" type="checkbox"/> No
REPORT TYPE	<input checked="" type="checkbox"/> Initial <input type="checkbox"/> Interim <input type="checkbox"/> Final		
ANNEXES	<input checked="" type="checkbox"/> Yes <input type="checkbox"/> No		

**SUBJECT OF INSPECTION**

Prestressed steel wire ropes for Seismic Brace System were subjected to tensile test under dynamic loads by following the test procedure in ANSI/ASHRAE Standart 171-2017 to rate the capacity of seismic and wind restraints of ropes and seismic link system which Link Yapı San. ve Tic. A.Ş. has (See Table 1.) and to evaluate the minimizing ability about the differential movement between a component and the supporting building structure during an earthquake or a high-wind event by determining the maximum loads the single directional single axis restraint can withstand without breakage or excessive deformation.

\* ANSI/ASHRAE Standart 171-2017 was accepted as guide during inspection.

Model	Diameter (mm)	Serial Number
STB 11	1.6	0334.1.STB.511G
STB 12	2.4	0334.1.STB.512G
STB 13	3.2	0334.1.STB.513G
	4.8	0334.1.STB.515G

Table 1. Product Tested

**PROJECT PROGRESS**

Three sample of each model were subjected to test for each angle 30°, 45° and 60° by using fixtures to arrange the angles. Anticipated maximum capacity loads (See Table 2) were declared by Link Yapı San. ve Tic. A.Ş. Conformity of loading cycles and frequencies were controlled and approved for each model acc. to ANSI/ASHRAE Standart 171-2017. Load application frequency was seen as 0.1 Hz as indicated in the standart. Loadings were done in periodic and continuous cycles. It was seen that Link Yapı San. ve Tic. A.Ş. followed the loading steps below as indicated in the standart.

22-IS-0424

**PROLINK G PROFILE**  
**&**  
**PLGMK EASY-LOCK SEISMIC TESTS**
**INSPECTION REPORT**

**Inspection Requesting:** LINK YAPI SAN. VE TIC. A.Ş.  
 Gebze Organize Sanayi Bölgesi, 1000. Sokak, NO:1016,  
 Çayırova - Kocaeli

**Inspection Address:** SABANCI ÜNİVERSİTESİ  
 İstanbul Teknoloji Geliştirme Bölgesi,  
 Teknopark Bulvarı, No:1 34906 Pendik /İSTANBUL

**Inspection Dates:** 28.03.2022

**Report No:** 22-IS-0424-TAT-22-0139

**Report Date:** 23.06.2022

**Report Published:** TÜV AUSTRIA TURK Belgelendirme Eğitim ve Gözetim Hizmetleri Ltd.  
 Şti.  
 Çamlık Mah. İbkal Cad. Diğ Sok. No:28/1 Ümraniye / İstanbul



Technical and Test Institute  
 for Construction Prague  
 Prosecká 811/76a  
 190 00 Prague  
 Czech Republic  
 ecta@zrus.cz



www.eta.eu

**European Technical Assessment**
**ETA 18/0441**  
 of 03/06/2018

**Technical Assessment Body issuing the ETA:** Technical and Test Institute for Construction Prague

**Trade name of the construction product** LT

**Product family to which the construction product belongs** Product area code: 33  
 Torque controlled expansion anchor for use in uncracked concrete

**Manufacturer** LINK YAPI SAN. VE TIC. A.Ş.  
 GOSB 1000 CD. NO:1016  
 ÇAYIROVA – GEBZE  
 KOCAELİ  
 TURKEY

**Manufacturing plant** Manufacturing Plant No 2

**This European Technical Assessment contains** 10 pages including 8 Annexes which form an integral part of this assessment

**This European Technical Assessment is issued in accordance with regulation (EU) No 305/2011, on the basis of** EAD 330232-00-0601  
 Mechanical fasteners for use in concrete

**This version is a corrigendum to** ETA 18/0441 of 03/06/2018

Translations of this European Technical Assessment in other languages shall fully correspond to the original issued document and should be identified as such.

Communication of this European Technical Assessment, including transmission by electronic means, shall be in full (excepted the confidential Annex(es) referred to above). However, partial reproduction may be made, with the written consent of the issuing Technical Assessment Body - Technical and Test Institute for Construction Prague. Any partial reproduction has to be identified as such.

FIRST QUALITY CERTIFICATION

## SERTİFİKA

Bu Sertifika,  
**LİNK YAPI SANAYİ VE TİCARET ANONİM ŞİRKETİ**  
 Gebze Organize Sanayi Bölgesi 1000.Sokak No:1016  
 Çayırova / Kocaeli / Türkiye

kuruluşunun,  
**BORU ASKI VE DESTEK SİSTEMLERİ, HAVA KANALI BAĞLANTI SİSTEMLERİ, SES VE YİTİŞİM KONTROL SİSTEMLERİ, SİSMİK SINIRLAYICILAR, PROLINK YAPI PROFİLLERİ VE BAĞLANTI ELEMANLARI PROCON ENDÜSTRİYEL YAPI PROFİLLERİ VE BAĞLANTI ELEMANLARI, ENDÜSTRİYEL YAPI SİSTEMLERİ**

EA 17  
 kapsamında,  
**ISO 9001:2015**

Kalite Yönetim Sistemi standartlarının şartlarına uyan bir yönetim sistemi kurduğunu ve uyguladığını onaylamak üzere verilmiştir.

**İlk Veriliş Tarihi** : 24.03.2009  
**Belge Geçerlilik Tarihi** : 23.03.2021  
**Belge Tarihi** : 23.03.2022  
**Belge Periyodu** : 3 Yıl  
**Bitiş Tarihi** : 23.03.2023  
**Sertifika No** : 01.09.0440.5317.D

First Quality Certification  
 Sistem Akademi Kurumları  
 Maltepe / İstanbul / Türkiye

**FOC, India & Nepal Office**  
 FOC (First Quality Certification) Pvt. Ltd.  
 303 37, Sector 12, Park Road - Gurgaon, Haryana, India  
 T: +91 121 6262070 F: +91 121 4442020  
 www.focindia.com info@focindia.com

**FOC, Turkey & Critical Location**  
 FOC (First Quality Certification) Inc. USA, Inc.  
 6000 Main, Tolland Ct. No 1210 Blok A D. 29-29 Mahallesi / İstanbul / Türkiye  
 T: +90 216 848 21 61 F: +90 216 422 90 80 F: +90 216 422 90 80  
 www.focgroup.com info@focgroup.com

Bu belge, diğer belgeyi FOC'nin kuralları ve diğer belgeyi parantez içinde gösterildiği şekilde Sertifika gruplarına FOC'ün internet sitesinde talep edilebilir.  
 This document shall remain valid as long as the customer abides FOC rules and terms of the contract. Certificate validity may be checked on FOC website.